

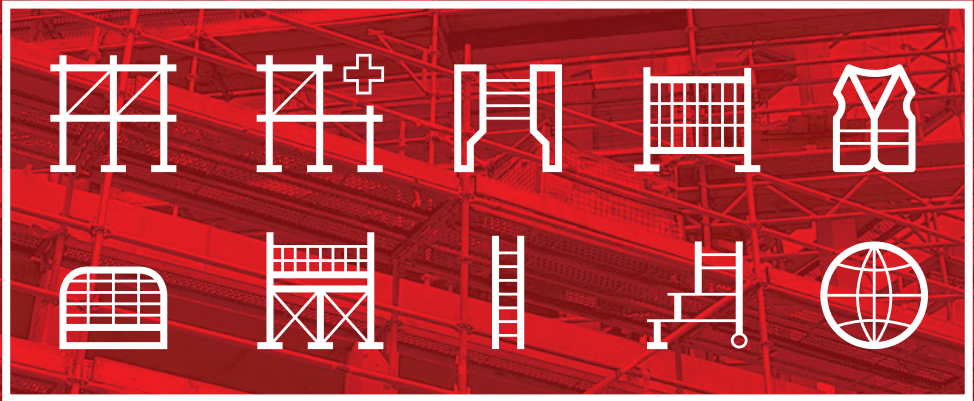

# ALTRAD GENERATION

HIRE & SALE



## PRODUCTS & SERVICES GUIDE



# Altrad Generation Hire & Sale

## Support for Construction & Industry

Altrad Generation is the UK's leading supplier of: Scaffolding, Temporary Fencing, Light Access, Edge Protection, Safety Decking and Groundworks for hire and sale.

### OUR **CUSTOMER COMMITMENT** IS TO DELIVER:



#### **BEST QUALITY**

We work closely with our suppliers to ensure consistent product quality every time. All our products are specified to meet or exceed statutory requirements, verified by our Quality Assurance team.



#### **BEST AVAILABILITY**

Our nationwide branch network, transport fleet and stock holding ensure we can supply your equipment needs. What, When and Where you need equipment.



#### **BEST PARTNERSHIP**

We can take care of all your equipment needs; supplemented by a full range of engineering, design, specification and business services. Our focus is to work together, supporting the growth of your business.



#### **BEST VALUE**

Our global supply chain, purchasing and lean business means we don't pass on unnecessary costs to you. We aim to provide consistently low prices and the best value when you buy or hire from us.

# Contents

## Scaffolding



Scaffold Tube .....	8
Scaffold Fittings.....	9-11
Scaffold Boards.....	12-13
Aluminium & Steel Beams .....	14-20
Loading Bay Gates .....	21-22
Scaffold Ancillaries .....	23-26
Brickguards .....	27
Scaffold Tools.....	28-29
Sheeting & Debris Netting.....	30-35
Scaffold Storage.....	36
Q-Clamps .....	37-41

## System Scaffold



Extendable Transom & Bracket .....	44
Readylok Transom.....	45
Genlok System Scaffold .....	46-53
Genlok System Scaffold Stair Tower .....	54-58
Futuro Ring System Scaffold .....	59-77
UNI-Roof Temporary Roofing System.....	78-93
Estimating Software .....	94
Temporary Roof Sheetting.....	95
Trax Bracket .....	96-101
Generation Stair Tower.....	102-107
Ranger Stair.....	108
Layher .....	109-110

### Disclaimer

Whilst Generation (UK) Ltd has taken every reasonable effort to ensure the information contained within this publication is correct and complete at the time of printing, you should be aware that there will be periodical changes and Generation (UK) Ltd does not accept any liability for any inconvenience, loss or damage caused as a result of any inaccuracy or omission within this publication.

### Copyright

No unauthorised reproduction of any images, text or other matter contained herein is permitted. All rights are expressly reserved, including copyright, design right, moral and patent rights (where applicable). We reserve the right to take legal action in respect of any infringement of said rights.

# Contents

## Groundworks



Services .....	114-117
Trench Boxes .....	118-124
Drag Boxes .....	125-128
Manhole Boxes .....	129-135
Trench Box Safety Ancillaries .....	136-138
Alloy Waler Rails .....	139-140
Standard Hydraulic Manhole Brace .....	141
Mammoth Plus .....	141-145
Trench Sheetting .....	146-149
Groundwork Ancillaries .....	150-153
Ground Protection .....	154-158
Roadforms .....	159
Additional Services .....	160

## Fencing, Hoarding & Barriers



Fencing, Barriers, Hoarding & Water Filled Barriers .....	164
Temporary Fencing .....	165-166
Fencing Stability .....	167-169
Fencing Accessories .....	170-174
Temporary Steel Hoarding .....	175
Hoarding Stability .....	176-177
Hoarding Accessories .....	178-180
Wind Resistance Calculator .....	181
Pedestrian Barriers .....	182-185
Traffic Management Barriers .....	186-190

## Safety Products



Safety Harnesses .....	194
Fall-Pac Landing Bags .....	195-196
Air Deck .....	197



# Contents

## Edge Protection



Introduction .....	200-203
Steel Frame Solutions .....	204-205
Concrete Frame Solutions .....	206-209
Timber Frame Solutions .....	210-211
Staircase Solutions .....	212-215
Demarcation.....	216
Safeguard Roof Edge Protection.....	217
Lift Shaft Solutions .....	218
Access Gate Solutions .....	219
Service & Support .....	220-221
Combisafe Edge Protection & Fall Protection System.....	222-223
Steel Frame Solutions .....	224-225
Concrete Frame Solutions .....	226-228
Full Height Debris Containment Solutions .....	229-230
Staircase Edge Protection.....	231-232

## Rhino Load Deck Safety System



Working at Height Regulations .....	236
Fall Prevention Solution.....	237
Working at Height.....	238
Training Certification.....	239
Install & Dismantle Service.....	239
Features & Benefits .....	240-241
Rhino Loading Deck Components .....	241-245

## Ladders & Builders Products



Scaffold Ladders .....	248
Ladder Safety Products.....	249
Steel Props.....	250
Trestle Handrail System.....	251
Strongboy® Masonary Wall Supports .....	252

# Contents

## Specialist Light Access



Specialist Modular Alloy Systems .....	256
Light Access Accessories .....	257-258
Betaguard® Advanced Guardrail .....	259
MAST 250 Aluminium Span Tower .....	260
MAST Low Level Folding Platforms .....	261
BoSS Aluminium Span Tower .....	262
BoSS GRP Zone 1 Tower .....	263
BoSS Ladderspan & Clima Tower .....	264
Low Level Access Platforms .....	265
Stagings .....	266
Aluminium Step Access .....	267
Aluminium Ladder Access .....	268
Spandek Walkway System .....	269

## Altrad Generation Export



Stock & Experience .....	272
Freight .....	273
Quality Control .....	274

## Accreditations & Associations



NATIONAL ACCESS & SCAFFOLDING  
CONFEDERATION



**LOGISTICS UK**  
THE NEW NAME FOR FTA



# Scaffolding

Scaffold Tube

Scaffold Fittings

Scaffold Boards

Aluminium & Steel Beams

Loading Bay Gates

Scaffold Ancillaries

Brickguards

Scaffold Tools

Sheeting & Debris Netting

Scaffold Storage

Q-Clamp





## Scaffold Tube



Altrad Generation supplies a number of scaffold tube options including both standard 4mm EN39 and 3.2mm High Yield Steel Tube or Aluminium EN 10219-1 in a range of lengths that are compatible for both commercial and private building projects. If you're not sure what Grade of scaffold tube you require, contact your local branch for more information. We're happy to help.

### 4mm Hot Dipped Galvanised Tube

Available in various lengths up to 6.40m (21') Fully conforming to EN39:2001 Grade S235GT 48.3mm diameter x 4mm nominal wall thickness. Product Tested and Certified

Code	Length	Code	Length	Code	Length
015205	5'	015210	10'	015221	21'
015206	6'	015213	13'		
015208	8'	015216	16'		

### 3.2mm High Yield Galvanised Tube

Available in various lengths up to 6.40m (21') Fully conforming to BS EN10219-1 Grade S355JOH 48.3mm diameter x 3.2mm nominal wall thickness. Product Tested and Certified

Code	Length	Code	Length	Code	Length
016905	5'	016910	10'	016921	21'
016906	6'	016913	13'		
016908	8'	016916	16'		

### High Quality Aluminium Tube

Available in lengths up to 6.09m (20') Conforms EN755-2 Grade 6082 T6 48.3mm diameter x 4mm nominal wall thickness. Product Tested and Certified

Code	Length	Code	Length	Code	Length
015305	5'	015310	10'	015320	20'
015306	6'	015313	13'		
015308	8'	015316	16'		

# Scaffold Fittings



<b>Code</b>	<b>026001</b>
<b>Desc.</b>	Drop Forged Double Coupler
<b>Wt.</b>	1.00kg



<b>Code</b>	<b>026002</b>
<b>Desc.</b>	Drop Forged Swivel Coupler
<b>Wt.</b>	1.00kg



<b>Code</b>	<b>026003</b>
<b>Desc.</b>	Drop Forged Putlog Coupler
<b>Wt.</b>	0.60kg



<b>Code</b>	<b>026124</b>
<b>Desc.</b>	Pressed Steel Double Coupler
<b>Wt.</b>	1.00kg



<b>Code</b>	<b>026125</b>
<b>Desc.</b>	Pressed Steel Swivel Coupler
<b>Wt.</b>	1.00kg



<b>Code</b>	<b>026126</b>
<b>Desc.</b>	Pressed Steel Putlog Coupler
<b>Wt.</b>	0.60kg



<b>Code</b>	<b>026005</b>
<b>Desc.</b>	Pressed Sleeve
<b>Wt.</b>	1.10kg



<b>Code</b>	<b>026006</b>
<b>Desc.</b>	Pressed Joint Pin
<b>Wt.</b>	1.10kg

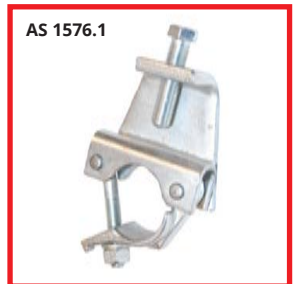

<b>Code</b>	<b>026201</b>
<b>Desc.</b>	Girder Coupler (Use in Pairs)
<b>Wt.</b>	1.56kg





# Scaffold Fittings



<b>Code</b>	<b>026030</b>
<b>Desc.</b>	Band & Plate
<b>Wt.</b>	2.00kg



<b>Code</b>	<b>045040</b>
<b>Desc.</b>	Board Clamp
<b>Wt.</b>	0.60kg



<b>Code</b>	<b>045038</b>
<b>Desc.</b>	Limpet Clamp
<b>Wt.</b>	0.60kg



<b>Code</b>	<b>026007</b>
<b>Desc.</b>	Toe Board Clip
<b>Wt.</b>	0.20kg



<b>Code</b>	<b>026009</b>
<b>Desc.</b>	Putlog Head
<b>Wt.</b>	0.40kg



<b>Code</b>	<b>048072</b>
<b>Desc.</b>	External Hook Coupler
<b>Wt.</b>	1.03kg



<b>Code</b>	<b>048071</b>
<b>Desc.</b>	Internal Hook Coupler
<b>Wt.</b>	0.80kg

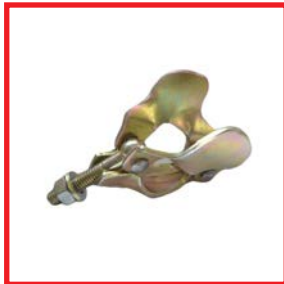

<b>Code</b>	<b>026040</b>
<b>Desc.</b>	Oyster Coupler
<b>Wt.</b>	0.70kg



<b>Code</b>	<b>046229</b>
<b>Desc.</b>	Roofing Coupler
<b>Wt.</b>	1.00kg

## Scaffold Fittings



<b>Code</b>	<b>046911 &amp; 046107</b>
<b>Desc.</b>	Restraining Eye
<b>Dim.</b>	23mm x 120mm 23mm x 160mm



<b>Code</b>	<b>046106</b>
<b>Desc.</b>	Restraining Eye
<b>Dim.</b>	50mm x 160mm



<b>Code</b>	-
<b>Desc.</b>	Nylon Plugs
<b>Dim.</b>	-

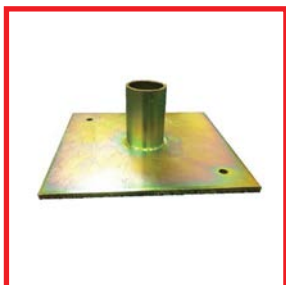

<b>Code</b>	<b>026016</b>
<b>Desc.</b>	British Standard Base Plate
<b>Wt.</b>	0.90kg



<b>Code</b>	<b>026004</b>
<b>Desc.</b>	Base Plate Tube
<b>Wt.</b>	0.40kg

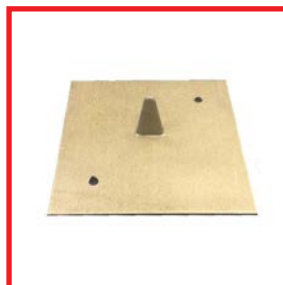

<b>Code</b>	<b>026008</b>
<b>Desc.</b>	Pressed Base Plate
<b>Wt.</b>	0.40kg



<b>Code</b>	<b>045039</b>
<b>Desc.</b>	Ladder Clamp
<b>Wt.</b>	1.00kg



<b>Code</b>	<b>026510</b>
<b>Desc.</b>	Tamer® Fitting
<b>Wt.</b>	-



<b>Code</b>	<b>026511</b>
<b>Desc.</b>	Klawz Fitting
<b>Wt.</b>	-



# Scaffold Boards

## Timber Boards



All our boards are made to the exacting standards of BS 2482:2009 using visually or machine graded timber with support spans of up to 1.2m or machine stress graded with support spans of up to 1.5m.

Available in standard industry sizes, all scaffold boards can be branded and banded with your company's name upon request as well as nail-plated.

Code	Description	Depth	Width	Weight
034009	3ft Timber Scaffold Board - 1.2m Support	38mm	225mm	4.26kg
034007	4ft Timber Scaffold Board - 1.2m Support	38mm	225mm	5.68kg
034008	5ft Timber Scaffold Board - 1.2m Support	38mm	225mm	7.10kg
034006	6ft Timber Scaffold Board - 1.2m Support	38mm	225mm	8.52kg
034002	8ft Timber Scaffold Board - 1.2m Support	38mm	225mm	11.36kg
034005	10ft Timber Scaffold Board - 1.2m Support	38mm	225mm	14.20kg
034001	13ft Timber Scaffold Board - 1.2m Support	38mm	225mm	18.46kg

Code	Description	Depth	Width	Weight
034105	5ft Timber Scaffold Board - 1.5m Support	38mm	225mm	7.70kg
034106	6ft Timber Scaffold Board - 1.5m Support	38mm	225mm	9.20kg
034108	8ft Timber Scaffold Board - 1.5m Support	38mm	225mm	12.30kg
034110	10ft Timber Scaffold Board - 1.5m Support	38mm	225mm	15.40kg
034113	13ft Timber Scaffold Board - 1.5m Support	38mm	225mm	20.00kg

Code	Description	Depth	Width	Weight
034013	1" Scaffold Board Bands	-	-	0.09kg
034018	18inch / 450mm Sole Pads	38mm	225mm	2.00kg

# Scaffold Boards

## Steel Scaffold Boards - Sale Only

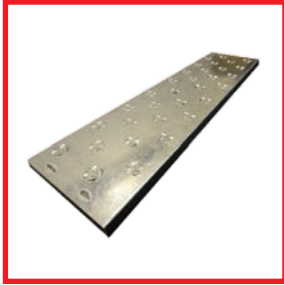

Available in various lengths between 3ft and 13ft.  
Conforms to BS EN 12811-1.

Fire retardant and long lasting, perfect for harsh environments and use in onshore and offshore facilities.

Code	Description	Depth	Width	Weight
<b>037003</b>	3' Galvanised Steel Board	38mm	225mm	5.10kg
<b>037004</b>	4' Galvanised Steel Board	38mm	225mm	6.80kg
<b>037005</b>	5' Galvanised Steel Board	38mm	225mm	8.50kg
<b>037006</b>	6' Galvanised Steel Board	38mm	225mm	10.20kg
<b>037008</b>	8' Galvanised Steel Board	38mm	225mm	13.60kg
<b>037010</b>	10' Galvanised Steel Board	38mm	225mm	17.00kg
<b>037013</b>	13' Galvanised Steel Board	38mm	225mm	22.00kg



### Plastic Scaffold Board (Supadeck)

Supadeck is a unique lightweight decking system that is strong and durable. It is easier, safer and cleaner to use than steel and traditional timber boards.

Supadeck for tubular scaffolding 45mm x 225mm clear spans of at least 1.5m. Weight @ 3.9m - 13kg

Supadeck for batten applications 63mm x 225mm clear spans of at least 2.4m. Weight @ 2.4m - 11.5kg

Code	Description	Depth	Width	Weight
<b>038005</b>	1.5m Supadeck Board	45mm	225mm	6.15kg
<b>038008</b>	2.4m Supadeck Board	45mm	225mm	9.85kg
<b>038010</b>	3.0m Supadeck Board	45mm	225mm	12.30kg
<b>038013</b>	3.9m Supadeck Board	45mm	225mm	16.00kg



# Aluminium & Steel Beams

## 450mm High Capacity Alloy Beam



The Aluminium 450mm Beam has been the market leader in the UK & Europe for more than 20 years. It provides significant time and cost savings across a whole range of scaffold structures.

Suspended or mobile platforms, birdcages, protection-decks bridges or temporary roofs are ideal applications for the Aluminium 450mm Beam.

The Aluminium 450mm Beam has been specifically designed to provide the highest possible UDL. The unique design allows connection directly to the node point between the diagonals, achieving maximum loading. This means, in most applications, the lowest number of beams are required. In addition, beams are quickly and simply joined together with straight connectors using fast action spring clips.



Code	Description	BS EN 1999-1 (1.0m Restraints)		Weight
		Perm. Shear	Perm. Moment	
<b>277499</b>	4.1m x 450mm Beam	11.66kN	20.19kNm	17.00kg
<b>277490</b>	6.1m x 450mm Beam	11.66kN	20.19kNm	23.00kg
<b>277500</b>	8.1m x 450mm Beam	11.66kN	20.19kNm	31.00kg
<b>277631</b>	60mm Spring Clip	-	-	0.03kg
<b>277501</b>	450mm 6 Hole Steel Spigot	-	-	1.13kg

# Aluminium & Steel Beams

## Asterix 750 Beam

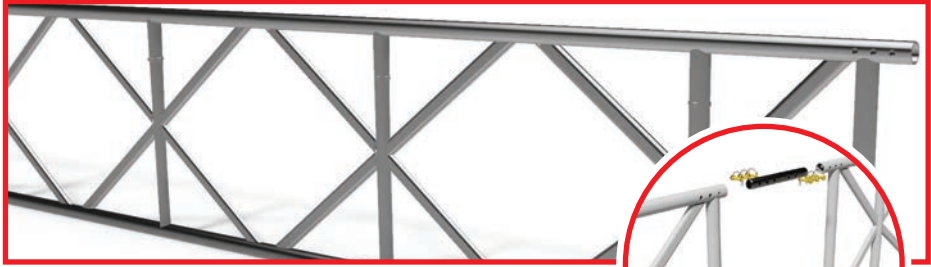

The Asterix 750 Beam is totally compatible with the Diamond Beam with superior capacity and also fits the X-Beam (capacity not equivalent).

All chords and posts are manufactured in traditional scaffold tube size. Vertical posts are provided every 1m on all beam sizes.

The Asterix 750 Beam also offers consistent node spacing when multiple beams are joined. The node points are spaced to allow connection of a standard scaffold fitting at any point.

18 degree, 12 degree and 6 degree ridge beams available.

Consistent diagonal node spacing when multiple beams are joined.

Closed end beams so whole length can be used for support unlike other 750 beams where end support has to be set in 0.5m each side, effectively wasting 1m of beam each time.

Joined using simple spigots and quick release spring clips.

Suitable for use with Temporary Roofing Systems.

### Conforms to BS EN 1999-1-1 Eurocode 9

Code	Description	BS EN 1999-1 (1.0m Restraints)		Weight
		Perm. Shear	Perm. Moment	
<b>397010</b>	1.0m x 750mm Beam	23.73kN	41.30kNm	6.94kg
<b>397020</b>	2.0m x 750mm Beam	23.73kN	41.30kNm	12.72kg
<b>397030</b>	3.0m x 750mm Beam	23.73kN	41.30kNm	18.49kg
<b>397040</b>	4.0m x 750mm Beam	23.73kN	41.30kNm	24.27kg
<b>397050</b>	5.0m x 750mm Beam	23.73kN	41.30kNm	11.75kg
<b>397060</b>	6.0m x 750mm Beam	23.73kN	41.30kNm	19.61kg
<b>397001</b>	6 Hole Steel Spigot	-	-	0.70kg
<b>277631</b>	60mm Spring Clip	-	-	0.03kg



# Aluminium & Steel Beams

## X-Beam



X-Beam is a high strength and high quality alternative to conventional methods. Specially designed for capacity and lightness X-Beams are the safe, labour saving alternative. Suitable for all applications such as crash decks, spine beams, temporary bridges, large span temporary roofs and suspended scaffolds.

Available for both hire and sale they provide a cost effective solution for any application saving erection time and mechanical handling. Beams are erected quickly and more safely where possession times are critical.

Its strength and self-weight allows less associated equipment in the structure.

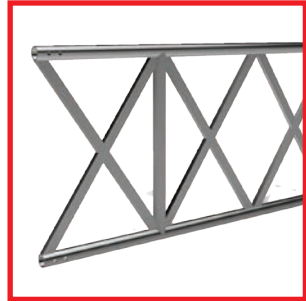

### Conforms to BS EN 1999-1-1 Eurocode 9

Code	Description	BS EN 1999-1 (1.0m Restraints)		Weight
		Perm. Shear*	Perm. Moment*	
<b>395001</b>	1.0m x 750mm Beam	35.00kN	33.00kNm	8.00kg
<b>395003</b>	3.0m x 750mm Beam	35.00kN	33.00kNm	24.00kg
<b>395004</b>	4.0m x 750mm Beam	35.00kN	33.00kNm	32.00kg
<b>395010</b>	Spigot c/w Nut and Bolt	-	-	0.69kg

\*Varies with span, please refer to full specification.



# Aluminium & Steel Beams

## D780mm Alloy Beam

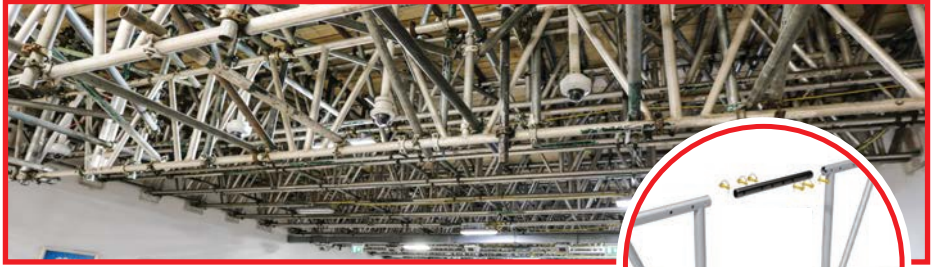

Main structural component for creation of roof spans, also suitable for everyday general purpose applications. The user friendly D78 Beam range offers unrivalled cost to weight ratio and is equally at home in a heavy duty support scaffold or an elegant roofing application

- High strength, low weight and maximum versatility.
- Manufactured in traditional scaffold tube size.
- Vertical posts are provided each 1m on all beam sizes.



### Conforms to BS EN 1999-1-1 Eurocode 9

Code	Description	BS EN 1999-1 (1.0m Restraints)		Weight
		Perm. Shear	Perm. Moment	
440004	0.5m Beam	23.71kN	38.8kNm	4.30kg
440005	1.0m Beam	23.71kN	38.8kNm	6.34kg
440006	2.0m Beam	23.71kN	38.8kNm	11.63kg
440007	3.0m Beam	23.71kN	38.8kNm	16.92kg
440008	4.0m Beam	23.71kN	38.8kNm	22.21kg
440009	5.0m Beam	23.71kN	38.8kNm	27.50kg
440010	6.0m Beam	23.71kN	38.8kNm	32.79kg
440071	6 Hole Steel Spigot	-	-	1.49kg
277631	60mm Spring Clip	-	-	0.03kg



# Aluminium & Steel Beams

## 780mm Aluminium Beam



The 780 Aluminium Beam is high strength, low weight and has maximum versatility. The beam range has overall depths of 0.78m and comes in lengths from 2m to 6m.

All member components are manufactured in traditional scaffold tube size and vertical posts are provided each 1m on all beam sizes. It also has consistent node spacing when multiple beams are joined, and node points are spaced to connect a standard scaffold fitting at any point.

The beam can be joined using the Altrad Generation Spigot Connector.

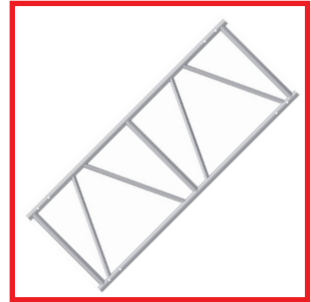

Code	Description	BS EN 1999-1 (1.0m Restraints)		Weight
		Perm. Shear	Perm. Moment	
440007	3.0m x 780mm Beam	30.70kN	36.50kNm	16.70kg
440008	4.0m x 780mm Beam	30.70kN	36.50kNm	22.00kg
440009	5.0m x 780mm Beam	30.70kN	38.80kNm	27.40kg
440010	6.0m x 780mm Beam	30.70kN	36.50kNm	32.70kg
440071	6 Hole Steel Spigot	-	-	0.08kg
277631	60mm Spring Clip	-	-	0.03kg

# Aluminium & Steel Beams

## 1.33m Heavy Duty Asterix Alloy Beam



### Single Beam Lines, Massive Spans

Multiple beam lines omitted for most applications, greatly simplifies lacing and bracing, massive reduction in fittings and labour.

### Special Design, Quality Manufacture

Optimum arrangement of internal members for maximum capacity and consistent node spacing. All beams closed end for stability and strength, spigot jointed.

### Brace with System or Tube and Fittings

Asterix HD Beam depth enables use of system K frames for both plan and section bracing, meaning large beams can be braced in minutes. Alternatively, traditional tube and fittings can be used for both lacing and bracing. Unlike most other scaffold beams on the market today it is permissible to connect scaffold couplers to the posts of Asterix HD.

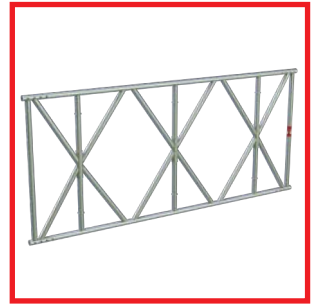

Code	Description	BS EN 1999-1 (1.0m Restraints)		Weight
		Perm. Shear	Perm. Moment	
396055	0.55m x 1.33m Beam	32.60kN	102.20kNm	6.33kg
396100	1.0m x 1.33m Beam	32.60kN	102.20kNm	13.33kg
396200	2.0m x 1.33m Beam	32.60kN	102.20kNm	22.60kg
396300	3.0m x 1.33m Beam	32.60kN	102.20kNm	31.87kg
396400	4.0m x 1.33m Beam	32.60kN	102.20kNm	41.13kg
396900	8 Hole Steel Spigot	-	-	1.44kg
277631	60mm Spring Clip	-	-	0.03kg



# Aluminium & Steel Beams

## Ladder Beams



Steel Ladder Beams are an economical, versatile structural steel support beam available for hire or sale, fully compatible with traditional tube and fittings and used to enable clear spans to be constructed between adjacent scaffolding structures. Ideally suited to long term applications and used extensively on high level pavement gantries, heavy duty loading bays, cantilevered structures, temporary shores, truss out scaffolds and slung / suspended structures.



### Also Available Galvanised and Aluminium Ladder Beams

Call your nearest branch for further details

#### Max moment are for spans over 3.7m

Code	Description	BS EN 1999-1 (1.0m Restraints)		Weight
		Perm. Shear	Perm. Moment	
<b>055015</b>	6ft (1.8m) Steel Ladder Beam	20.00kN	12.70kNm	18.40kg
<b>055073</b>	8ft (2.4m) Steel Ladder Beam	20.00kN	12.70kNm	24.50kg
<b>055070</b>	10ft (3.0m) Steel Ladder Beam	20.00kN	12.70kNm	30.60kg
<b>055084</b>	13ft (3.9m) Steel Ladder Beam	20.00kN	12.70kNm	40.00kg
<b>055075</b>	16ft (4.8m) Steel Ladder Beam	20.00kN	12.70kNm	49.00kg
<b>055077</b>	21ft (6.4m) Steel Ladder Beam	20.00kN	12.70kNm	64.20kg

# Loading Bay Gates



Altrad Generation has a wide range of ancillary components which add safety to both system and tube and fitting scaffolds. Loading Bay Gates, Safety Handrail Gates and Ladder Locks are available to provide safety of operatives who work on finished scaffolds.

Loading Bay Gate Arms are supplied in pairs, manufactured in mild-steel and power coated for high durability.

All Loading Bay Gates can be erected with Standard Scaffold Tubes, Boards and Brick Guards.



## Double Handrail Staysafe

To be used in pairs, allowing two handrails to be used as well as allowing a Toe Board (Scaffold Board) to be fixed.

Fully compliant to  
**TG20 and BS EN 13374**

- Full box section frame with three welded half coupler scaffold fittings
- Operates within a 7 board loading bay
- No protrusion into the working platform
- 2185mm height required
- 1500mm loading depth
- 21kg per arm

Code	Description	Weight
278202	Double Handrail Staysafe	20.00kg



# Loading Bay Gates



## Triple Handrail Staysafe

To be used in pairs, allowing three handrails to be used.

Fully compliant to **TG20 and BS EN 13374**

- Full box section frame with two welded half coupler scaffold fittings and a toe board bracket
- Operates within a 6 board loading bay
- No protrusion into the working platform
- 1975mm height required
- 1350mm loading depth
- 20kg per arm
- Ideal for system scaffolding

Code	Description	Weight
278203	Triple Handrail Staysafe	14.70kg



## 'M' Loading Bay

To be used with tube and fittings. Additional fittings will be required to secure the gate.

Rear Guardrails must be fitted to comply with **TG20 and BS EN 13374**

- Box section and round tube frame, fully braced with 6mm flat bar
- Operates within a 7 board loading bay
- 1850mm height required (excluding scaffolding fittings)
- 1500mm loading depth
- 13kg per arm

Code	Description	Weight
278230	'M' Loading Bay Arm	20.00kg
278231	'M' Loading Bay Gate	20.00kg



## Scaffold Ancillaries



<b>Code</b>	<b>046224</b>
<b>Desc.</b>	Rubbish Chute Fixing Frame
<b>Wt.</b>	0.90kg



<b>Code</b>	<b>046222</b>
<b>Desc.</b>	Top Hopper Rubbish Chute
<b>Wt.</b>	10.00kg



<b>Code</b>	<b>046221</b>
<b>Desc.</b>	Rubbish Chute
<b>Wt.</b>	9.00kg



<b>Code</b>	<b>046223</b>
<b>Desc.</b>	Side Entry Rubbish Chute
<b>Wt.</b>	-



<b>Code</b>	<b>103116</b>
<b>Desc.</b>	Customisable Gladtag
<b>Wt.</b>	-



<b>Code</b>	<b>207005</b>
<b>Desc.</b>	6 Ton Standard Base Jack
<b>Wt.</b>	4.70kg



<b>Code</b>	<b>207200</b>
<b>Desc.</b>	6 Ton Swivel Base Jack
<b>Wt.</b>	4.30kg



<b>Code</b>	<b>046078/9</b>
<b>Desc.</b>	Rope - Sisal & Polypropylene
<b>Wt.</b>	0.10kg



<b>Code</b>	<b>026013</b>
<b>Desc.</b>	8" Rubber Solid Scaffold Castor
<b>Wt.</b>	6.50kg





## Scaffold Ancillaries



<b>Code</b>	<b>046037</b>
<b>Desc.</b>	10" Gin Wheel
<b>Wt.</b>	5.00kg



<b>Code</b>	<b>046235/6</b>
<b>Desc.</b>	Sign Board Frames
<b>Wt.</b>	5.00kg



<b>Code</b>	<b>046520</b>
<b>Desc.</b>	Warning Tape Adhesive
<b>Wt.</b>	0.10kg



<b>Code</b>	<b>048065</b>
<b>Desc.</b>	2m Foam Sleeving
<b>Wt.</b>	0.50kg

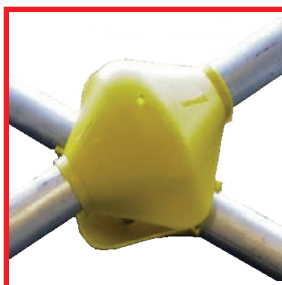

<b>Code</b>	<b>026000</b>
<b>Desc.</b>	Armadillo Fitting Cover
<b>Wt.</b>	0.12kg



<b>Code</b>	<b>046049/50</b>
<b>Desc.</b>	Tube End & Thread Caps
<b>Wt.</b>	0.01kg



<b>Code</b>	<b>135065</b>
<b>Desc.</b>	Alu. Scaffolders Step SG4
<b>Wt.</b>	6.20kg



For information on ladders see the **Ladders & Builders Products** Section

# Scaffold Ancillaries



## Steel Stair Tread

Code	Description	Length	Weight
046027	Steel Stair Tread	900mm	7.20kg
046028	Steel Stair Tread	1050mm	8.90kg
046029	Steel Stair Tread	1220mm	10.50kg



## Clip Lubricant

Code	Description	Length	Weight
040005	Clip Lubricant	5 Litres	5.00kg
040020	Clip Lubricant	20 Litres	20.00kg
040210	Clip Lubricant	208 Litres	208.00kg



Klipp-It is an all new universal clip system designed specifically for the attachment of various objects onto scaffolding. Unlike many current methods of fixing, it is quick, safe and secure to attach and detach.

It's unique design of slots and voids is idea for the quick and safe fixing of brick guards and debris sheeting, cables, banners, lights, signage, work packs and other items which have a keder edging strip.

Available In Other Colours

<b>Code</b>	<b>045123</b>
<b>Desc.</b>	Klipp-It
<b>Wt.</b>	-

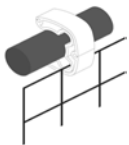

BRICK GUARDS



BANNERS & DEBRIS SHEETING



CABLE MANAGEMENT



SAFETY SIGNAGE



LIGHTING EQUIPMENT



# Scaffold Ancillaries

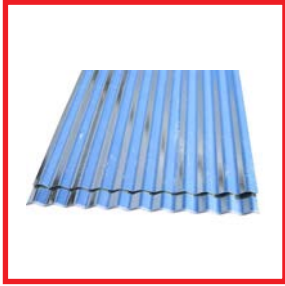

## Corrugated Iron Sheeting

Std Gauge	Imperial Thickness	Metric Thickness
22	0.0275" (0.0248")	0.70mm (0.63mm)
24	0.0236" (0.0213")	0.60mm (0.54mm)
26	0.0197" (0.0177")	0.50mm (0.45mm)



## Universal Friction Clamp

The Universal Friction Clamp can be fitted to horizontal, inclined or vertical tubular member of any diameter from 500mm upwards. Although it will have some resistance to loading applied parallel to the axis of the tubular member, it is intended to support loading applied at right angles to the axis. Maximum permissible applied load 3.kN and out of balance moment of 4.5kNm when applied.

Code	Description	Length
046027	Universal Friction Clamp	900mm
046028	Universal Friction Clamp	1050mm

To Calculate the length of chain required on a friction clamp:

**Pipe Dia. x 3.14 x 2 = min chain length**

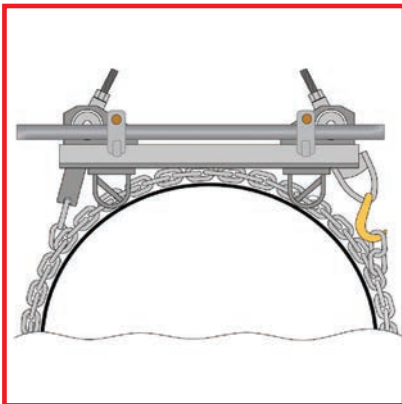

Diameter	Chain Length
500mm - 600mm	4000mm
600mm - 900mm	6000mm
900mm - 1200mm	8000mm

1200+ information available upon request

## Brickguards



### J.Mac Plastic Brickguards

Meets with TG20 and BSEN12811 standards.

The 'V' groove allows the Brickguard to run past scaffolding standards and over the rosettes. 2no. Toe Board Connectors give more security and improved fixing. It is also longer in height than other Brickguards on the market.

(J.Mac 945mm versus Max @ 840mm).

Code	Description	Weight
045130	J.Mac Black Plastic Brickguard	1.85kg
045131	J.Mac Blue Plastic Brickguard	1.85kg
045132	J.Mac Red Plastic Brickguard	1.85kg
045133	J.Mac Green Plastic Brickguard	1.85kg
045134	J.Mac Yellow Plastic Brickguard	1.85kg
045135	J.Mac Coloured Plastic Brickguard	1.85kg



### MAX Brickguards

Manufactured and tested to EN12811-1:2003 standards.

Complete one-piece construction with no separate parts to count or lose. Made from high grade impact modified polypropylene. A built in Toe Board Clip maximises safety even in high winds.

Code	Description	Weight
045108	Black Max Guard	1.00kg
045109	Blue Max Guard	1.00kg

Available In Other Colours



# Scaffold Tools

Large Stocks Available Nationwide

Altrad Generation provides a full range of scaffolders tools including spanners, ratchets and hammers - we are sure to have what you need. For our full range of tools, please contact your nearest branch on **0800 779 7113**.



<b>Code</b>	<b>046410</b>
<b>Desc.</b>	7/16" Poker Handle Spanner
<b>Wt.</b>	0.60kg



<b>Code</b>	<b>046412</b>
<b>Desc.</b>	7/16" Cromwell Spanner
<b>Wt.</b>	0.50kg



<b>Code</b>	<b>046415</b>
<b>Desc.</b>	7/16" Burton Plain Spanner
<b>Wt.</b>	0.50kg

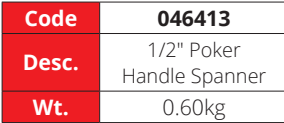

<b>Code</b>	<b>046413</b>
<b>Desc.</b>	1/2" Poker Handle Spanner
<b>Wt.</b>	0.60kg

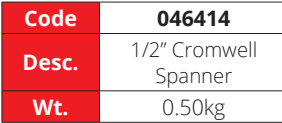

<b>Code</b>	<b>046414</b>
<b>Desc.</b>	1/2" Cromwell Spanner
<b>Wt.</b>	0.50kg

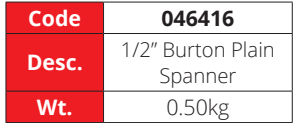

<b>Code</b>	<b>046416</b>
<b>Desc.</b>	1/2" Burton Plain Spanner
<b>Wt.</b>	0.50kg



<b>Code</b>	<b>046411</b>
<b>Desc.</b>	7/16" Chrome Flat Handle Spanner
<b>Wt.</b>	0.60kg



<b>Code</b>	<b>046428</b>
<b>Desc.</b>	Podger Hook
<b>Wt.</b>	0.50kg



<b>Code</b>	<b>046418</b>
<b>Desc.</b>	Podger Hammer
<b>Wt.</b>	-



# Scaffold Tools

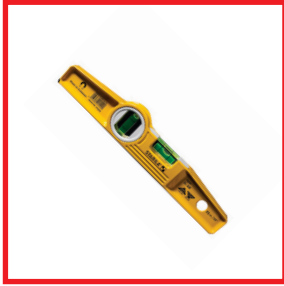

<b>Code</b>	<b>046074</b>
<b>Desc.</b>	Steel Magnetic Spirit Level
<b>Wt.</b>	0.20kg



<b>Code</b>	<b>046417</b>
<b>Desc.</b>	7/16" Ratchet Spanner
<b>Wt.</b>	0.30kg



<b>Code</b>	<b>046425</b>
<b>Desc.</b>	5m Steel Tape Measure
<b>Wt.</b>	0.10kg



<b>Desc.</b>	Various Belts, Frogs and Holders are available to suit all tools.
--------------	---



<b>Desc.</b>	Helmets Find more information in Safety Products
--------------	---



<b>Desc.</b>	Harnesses Find more information in Safety Products
--------------	---



# Sheeting and Debris Netting



## Monarflex Super T Plus

Monarflex Super T Plus is used for all types of long-term projects and is designed exceeding 12 months and conforms to BS7955:1999, BS8410:2007.

The combination of high quality components form a tough and durable sheeting option for very rough and extreme working conditions.

\*Firesmart option also available.\*

Code	Dimensions	Tensile Strength	Flame Retardant	Weight
046348	2.0m x 45.0m*	>630N/ 50mm	LPS 1207 and 1215 Cert No. 572d	34.00kg



## Monarflex Scaffband

Monarflex Scaffband can be used for all types of short term projects up to a max. duration of 6 months. The product is designed for normal weather conditions found in urban area with low rise buildings.

Designed to be installed with the Monarflex Flexitie fixing.

By using Monarflex Scaffband Clear you can meet deadlines and avoid economical surprises regardless of the weather and be safe in the knowledge that it fulfils all relevant British Standards like BS 7955:1999 and BS 8410:2007.

Code	Dimensions	Tensile Strength	Flame Retardant	Weight
046343	2.0m x 45.0m	>630N/ 50mm	-	19.00kg
046344	3.0m x 45.0m	>630N/ 50mm	-	28.00kg



## Monarflex Scaffband Flamesafe

Monarflex Scaffband Flamesafe is made from a three ply composition with the two outer layers being made from a weather resistant LDPE with flame retarder additives that encapsulates a strong multifilament polyester (PET) grid which forms the weather protection. On top of the sheet there are fixing bands of super high strength weave with a double coating over the bands to provide high durability. The bands are in pre-set patterns and with pre-made holes per 100mm making it fit virtually any type of scaffold. Conforms to British Standards like BS7955:1999 and BS 8410:2007

Code	Dimensions	Tensile Strength	Flame Retardant	Weight
046345	2.0m x 45.0m	>630N/ 50mm	LPS1215 Cert No. 572D	19.00kg
046346	3.0m x 45.0m	>630N/ 50mm	LPS1215 Cert No. 572D	28.00kg



# Sheeting and Debris Netting



## **Monarflex** Digi-Wrap

Digi-Wrap printing allows you to wrap any building in a powerful, highly visible message - from simple banners featuring your company logo to a full colour image creating a giant billboard.

- Fast production time of 2-3 weeks
- Minimum 6 month life of printed surface
- Sections are easily replaced if damaged



## **Powerclad Lite**

- Effective weather protection and containment system
- Improves working environment and site safety
- Woven reinforcement with waterproof coating
- Excellent low-temperature characteristics
- Digital printing for branding opportunities
- Double banding which allows for better fixing and overlaps

Code	Weight	Dimensions	Tensile Strength	Flame Retardant
-	<b>170gsm</b>	2.0 x 45m, 2.2 x 40m, 3.0 x 45m, 3.25 x 36m, 3.75 x 36m	Warp 500 N/500mm Weft 500 N/500mm	-



# Sheeting and Debris Netting



## Powerclad Flame Retardant Sheeting

- Effective weather protection and containment system
- Improves working environment and site safety
- Woven reinforcement with waterproof coating and
- Excellent low-temperature characteristics
- Digital printing for branding opportunities
- Certificated to BS 5867 Part 2B and BS 476 Part 12C

Code	Weight	Dimensions	Tensile Strength	Flame Retardant
-	170gsm	2.0 x 45m, 2.2 x 40m, 3.0 x 45m,	Warp >630 N/50mm Weft >630 N/50mm	LPS 1215 Cert No 965B LPS 1207 Cert No 965A



## Acoustic Noise Barrier Flame Retardant Sheeting

Measurable noise reduction minimises environmental impact close to noise sensitive sites. Powerclad Acoustic Sheeting features a special sound absorbing foam which provides both thermal insulation and sound absorption. Also available to fit perimeter fence panels.

Compliant to BS7955

Code	Weight	Dimensions	Tensile Strength	Flame Retardant
-	-	2.2m x 10m	-	EN13501-1 Class E



## Insulated Sheeting Flame Retardant Sheeting

Insulated sheeting incorporates cellular air cells which provide thermal insulation for improved working environments and those which require controlled atmospheres. It is widely used on projects where low temperatures and inclement weather conditions prevail. These materials are subject to minimum order quantities.

Compliant to BS7955

Code	Weight	Dimensions	Tensile Strength	Flame Retardant
-	-	2.2m x 20m 2.7m x 20m	-	DIN 4102 B1

# Sheeting and Debris Netting



## Filter Sheeting Flame Retardant

Closely woven air permeable mesh to contain debris and dust, dry out interior works, disperse paint solvents and air pressure during stone cleaning or shot-blasting. Filter sheeting is particularly recommended for exposed locations with high risk of wind acceleration.

Compliant to BS7955

Code	Weight	Dimensions	Tensile Strength	Flame Retardant
-	-	3.12m x 50m	-	BS476 part 12C (Complies with LPS 1215 sect 3.1.1)



## Vented Sheeting/ Perimeter Mesh Fencing

A more open weave than filter sheeting, Vented Sheeting provides higher air permeability. It is used to dry out interior works and disperse paint solvents and air pressure during stone cleaning or shot-blasting. It is also suitable as perimeter mesh fencing as it reduces wind forces on the fence. Also available in black for outdoor events and can be printed for corporate branding.

Compliant to BS7955

Code	Weight	Dimensions	Tensile Strength	Flame Retardant
-	-	1.76m x 50m 2m x 45m	-	BS476 Part 12C (complies with LPS 1215 Sect 3.1.1)



## Sheeting and Debris Netting



Custom Printing	Colours	Minimum Order	Print Area
Flexoprint - Repeat logo on scaffold sheeting and meshes	Standard 1 or 2 colour printing	30 rolls	Max Width 1070mm Max Height 730mm Repeats 1270mm
For projecting effective corporate branding. Largest print area in the industry			
Digiprint - Large logo on scaffold sheeting and meshes	Full-colour printing	No minimum order quantity	Unlimited
Wide format printing on scaffold sheeting and mesh. Ideal for promoting a development or project.			
Digiprint - Very large building wraps on PVC	Full-colour printing	No minimum order quantity	Unlimited
Wide format printing on PVC sheeting or open mesh to any size.			

# Sheeting and Debris Netting



## Fine Mesh Debris Netting

Available in a range of colours in sizes 2m x 50m and 3m x 50m

Altrad Generation concentrate on only supplying high quality, long life debris netting.

Altrad Generation's sheeting and debris netting meets and exceeds all relevant EN and BS Standards.

## Colours Available

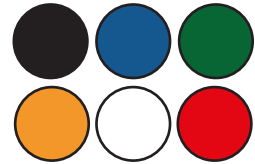

## Sheeting and Debris Netting Ties



<b>Code</b>	<b>046340</b>
<b>Desc.</b>	Cable Ties
<b>Wt.</b>	0.22kg

For use with debris netting.

100 ties per pack.  
1 Pack per roll.



<b>Code</b>	<b>046341</b>
<b>Desc.</b>	Flexitie
<b>Wt.</b>	1.50kg

046340 For use with Scaffband and Tri-Flex Sheeting.

100 ties per pack.  
1 Pack per roll.



<b>Code</b>	<b>046032</b>
<b>Desc.</b>	Anchor & Strap
<b>Wt.</b>	2.00kg

Recommended for use with Monarflex Extreme Firesmart & Extreme Super T Plus.

100 ties per pack.  
1 Pack per roll.



# Scaffold Storage



## U - Stacker

Altrad Generation's U-Stacker is designed to be used for the storage of tubes and boards as well as providing a safe and cost effective alternative to the traditional post pallet. Tested and designed to the structural design requirements of BS EN 2811 Temporary Works Equipment and BS EN 1993-1-1:2005 Eurocode 3 Design of Steel Structures.

**\*Based on 6.4m tube.**

Code	Description	Weight	Max Capacity	Stacking
041001	Size 1 U - Stacker	4.00kg	48 Tubes	5 Units High
041002	Size 2 U - Stacker	5.00kg	78 Tubes	3 Units High
041003	Size 3 U - Stacker	7.00kg	50 Boards	3 Units High



<b>Code</b>	<b>207777</b>
<b>Desc.</b>	Steel Stillage
<b>Wt.</b>	29.50kg



<b>Code</b>	<b>025555</b>
<b>Desc.</b>	Steel Bin
<b>Wt.</b>	50.00kg



<b>Code</b>	<b>026325</b>
<b>Desc.</b>	Fitting Sack
<b>Wt.</b>	2.50kg

# Q-Clamps

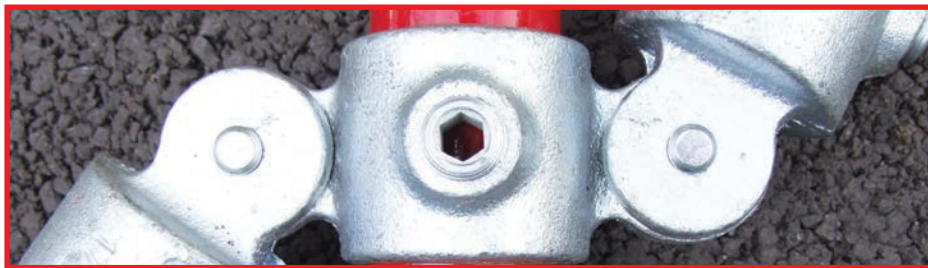

Over 50 types of Q-Clamps available for all uses and various tube sizes. Please visit our website or contact your nearest branch for the full range of fittings.

Size	Tube Diameter (mm O/D)	Normal Bore
1	26.9	3/4"
2	33.7	1"
3	42.4	1 1/4"
4	48.3	1 1/2"
5	60.3	2"

**Note:**  
Size 4 is standard scaffold tube

TÜV RHEINLAND Product Safety Type Approval Cert No: B061161671001

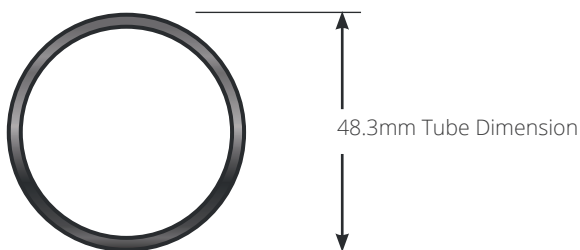

Galvanised tube available in Various lengths and thicknesses.

Galvanised Blackheart Malleable Iron fittings to BS6681, Grade B32-10 with galvanising to BS EN 1461:1999.

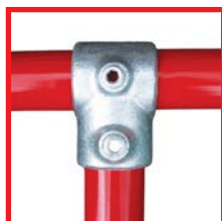

**013500**  
Q-Clamp **101-4**

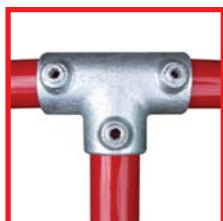

**013501**  
Q-Clamp **104-4**



**013503**  
Q-Clamp **116-4**

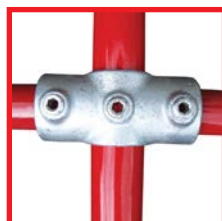

**013505**  
Q-Clamp **119-4**





## Q-Clamps



013433

Q-Clamp 123-4

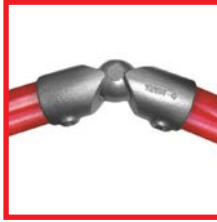

013347

Q-Clamp 125-4M

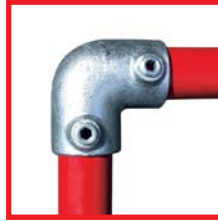

013507

Q-Clamp 125-4



013504

Q-Clamp 126-4



013506

Q-Clamp 127-4



013509

Q-Clamp 128-4



013511

Q-Clamp 129-4



013513

Q-Clamp 130-4



013515

Q-Clamp 131-4



013516

Q-Clamp 132-4

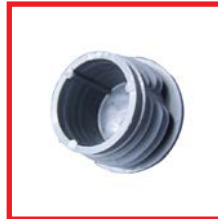

013517

Q-Clamp 133-4



013518

Q-Clamp 134-4



013519

Q-Clamp 135-4



013546

Q-Clamp 136-4

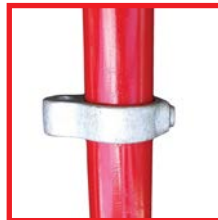

013520

Q-Clamp 138-4



013521

Q-Clamp 140-4



## Q-Clamps



013522

Q-Clamp 143-4



013438

Q-Clamp 144-4

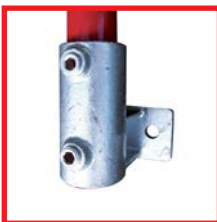

013448

Q-Clamp 145-4

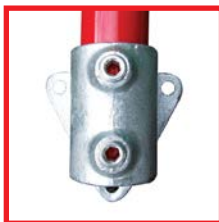

013524

Q-Clamp 146-4



013525

Q-Clamp 147-4



013526

Q-Clamp 148-4



013527

Q-Clamp 149-4



013528

Q-Clamp 150-4



013529

Q-Clamp 158-4

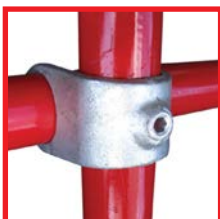

013406

Q-Clamp 160-4



013531

Q-Clamp 161-4



013348

Q-Clamp 161-4M

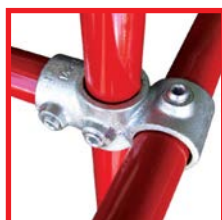

013510

Q-Clamp 165-4

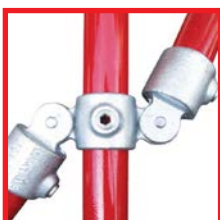

013532

Q-Clamp 167-4

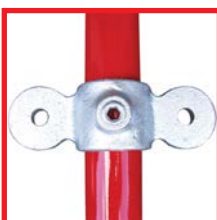

013530

Q-Clamp 167-4M



013533

Q-Clamp 168-4



## Q-Clamps



013535

Q-Clamp 168-4M



013534

Q-Clamp 169-4



013562

Q-Clamp 169M



013601

Q-Clamp 170-4



013566

Q-Clamp 171-4



013538

Q-Clamp 173-4

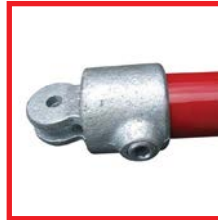

013434

Q-Clamp 173-4F



013539

Q-Clamp 173-4M



013541

Q-Clamp 176-4



013418

Q-Clamp 179-4

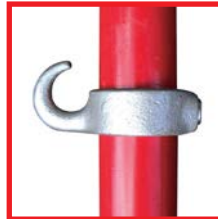

013545

Q-Clamp 182-4



013543

Q-Clamp 184-4



013622

Q-Clamp 185-4



013544

Q-Clamp 191-4



013446

Q-Clamp 198-4



013496

Q-Clamp 199-4

# Q-Clamps

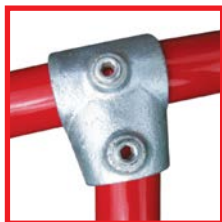

**013349**

Q-Clamp **201-4**



**013350**

Q-Clamp **204-4**



**013351**

Q-Clamp **219-4**



**013352**

Q-Clamp **224-4**



**013353**

Q-Clamp **225-4**



**013633**

Q-Clamp **232-4**



**013653**

Q-Clamp **246-4**



**013354**

Q-Clamp **247-4**



**013571**

Q-Clamp **300**



**013540**

Q-Clamp **301-4**



**013575**

Q-Clamp **302-4**



# System Scaffold

Extendable Transom & Bracket

Readylok Transom

Genlok System Scaffold

Genlok System Scaffold Stair Tower

Futuro Ring System Scaffold

UNI-Roof Temporary Roofing System

Estimating Software

Temporary Roof Sheeting

Trax Bracket

Generation Stair Tower

Ranger™ Stair

Layer



3D Modelling  
Software







## Extendable Intermediate Transom



A unique solution for the creation of boarded platforms within traditional tube and fitting scaffolds. Altrad Generation Extendable Intermediate Transoms combines three loose components into one easy to assemble item that is suitable for use with traditional tube and fittings, and with Readylok transoms.

Extendable Intermediate Transoms are suitable for the following scaffold types:

- Facade Access
- Inspection
- Lightweight & Medium
- Heavy Duty Scaffolds
- 1, 2, 3 inside boards loaded
- 4 or 5 board wide scaffolds

Code	Description	Weight
<b>278326</b>	Extendable Intermediate Transom 866mm (4+3)	9.00kg
<b>278328</b>	Extendable Intermediate Transom 1098mm (5+3)	9.90kg
<b>278334</b>	Extendable Transom 1.3m (5+3) Genlok with Stub	9.90kg
<b>278336</b>	Extendable Tube Transom (5+3)	8.60kg

## Extendable Hop-Up Bracket



Altrad Generation Extendable Hop Bracket complements tube and fittings and Readylok Transoms. The bracket allows a two or three inside intermediate board platform to be constructed, also allowing the benefits of the speed of adaptation of the intermediate inside platform thus saving labour.

2 + 1 Extendable Hop-Up Bracket

Code	Description	Weight
<b>278337</b>	Extendable Hop-Up Bracket	6.55kg



# Readylok Transom Unit



Altrad Generation Readylok Transom units will, at low cost immediately convert your stock of tube and fittings into an easily and speedily erected system scaffold, whilst maintaining TG20 compliant. The use of these pre-coupled units dramatically eliminates the need for loose fittings. In use they will considerably speed erection times reducing labour cost and site losses.



**Simplifies  
erection and  
striking**

**Cuts labour  
costs**

**Uses existing  
stocks of tube  
and fittings**

**Reduces  
site  
losses**



Altrad Generation Readylok Transoms are made to predetermined sizes, fully plated, with preset vertical and horizontal couplers to enable standards and ledgers to be perfectly positioned. This saves a considerable time in measuring and setting out. The result is a fast and fool proof system with its own, high, built in safety factor.

The Readylok Transom units are available for hire and sale in 5 board units, and available in 4 and 3 boards sizes.

Now included in TG20

Code	Description	Weight
<b>046531</b>	3 Board Readylok Transom	8.32kg
<b>046536</b>	4 Board Readylok Transom	8.66kg
<b>046515</b>	5 Board Readylok Transom	9.00kg

Readylok supplied by Generation UK Ltd has been audited by the NASC and has met the criteria to satisfy the NASC Code of Practice for proprietary System Scaffold Systems.

Readylok has been independently tested and has met or exceeded the criteria for Quality, Technical Specification and Compliance to BS EN 12811-1:2003 TG20 and EN 1991-1-4:2005.





# Genlok System Scaffold



Genlok is a safe and efficient system. It has a fast acting node point, a single hammer blow allows up to 4 components to be fastened at once. A full range is available to enable the system to be used with regular scaffold boards and steelstage battens in all configurations including: facade scaffolds, loading bays, staircase towers, circular structures and birdcages.

Genlok is fully tested and conforms in accordance with BS EN 12811-1 (Pt 1), BS EN 12811-2 (Pt 2) and BS EN 12811-3 (Pt 3) temporary works equipment scaffolds.

## Genlok in the Oil, Gas and Industrial Market

Altrad Generation has developed and introduced a number of specific products for use in pipe racks, modules and around fractionation columns that improve the flexibility and suitability of using their Genlok System Scaffold. These products deliver significant benefits over the traditional method of working, reducing the number of components used and limiting the possibility of dropped items whilst working.



## 6 Ton Adjustable Base

Code	Description	Weight
207005	6 Ton Adjustable Base	4.70kg
207200	Swivel Base Jack	4.30kg



## Genlok Standards

Code	Description	Length	Weight
227303	Standard 1.0m	1000mm	5.80kg
227302	Standard 2.0m	2000mm	11.20kg
227301	Standard 3.0m	3000mm	16.50kg

# Genlok System Scaffold



## Horizontal Ledgers

Code	Description	Length	Weight
227328	Horizontal Ledger 0.6m	600mm	2.75kg
227330	Horizontal Ledger 0.8m	800mm	3.25kg
227332	Horizontal Ledger 0.9m	900mm	3.35kg
227306	Horizontal Ledger 1.3m	1300mm	4.90kg
227305	Horizontal Ledger 1.8m	1800mm	7.00kg
227304	Horizontal Ledger 2.5m	2500mm	9.50kg
227406	Horizontal Ledger 3.0m	3000mm	11.50kg



## Swivel Face Brace

Code	Description	Bay Dimensions	Weight
227309	Swivel Face Brace	2500mm x 2000mm	11.50kg
227310	Swivel Face Brace	2500mm x 1500mm	10.70kg
227311	Swivel Face Brace	1800mm x 2000mm	9.80kg
227342	Swivel Face Brace	1800mm x 1500mm	8.70kg



## Omega Transom

Code	Description	Length	Weight
227349	OMEGA Transom	800mm	3.90kg
227348	OMEGA Transom	900mm	5.00kg
227346	OMEGA Transom	1300mm	7.20kg
227344	OMEGA Transom	1800mm	10.00kg



## Omega HD Transom 2.5m

Code	Description	Length	Weight
227347	OMEGA HD Transom 2.5m	2500mm	24.80kg



# Genlok System Scaffold

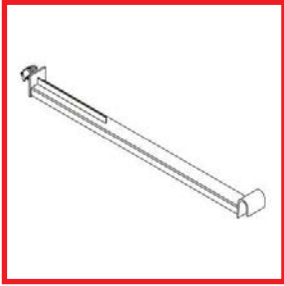

## Omega Ladder Access Transom

Code	Description	Weight
227333	OMEGA Ladder Access Transom	9.30kg



## Omega Return Transom

Code	Description	Weight
227366	OMEGA Return Transom	13.00kg



## Omega Steel Stage (Wide)

Code	Description	Length	Weight
227506	Steel Stage - 238mm x 57mm	600mm	4.33kg
227509	Steel Stage - 238mm x 57mm	900mm	6.50kg
227513	Steel Stage - 238mm x 57mm	1300mm	6.70kg
227518	Steel Stage - 238mm x 57mm	1800mm	9.10kg
227525	Steel Stage - 238mm x 57mm	2500mm	12.40kg

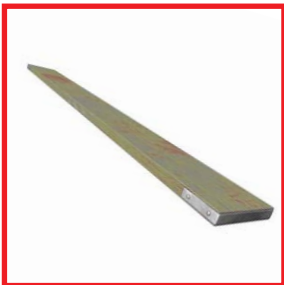

## Timber Batten - Sale Only

Code	Description	Length	Weight
227317	1.3m Timber Batten	1300mm	9.50kg
227363	1.8m Timber Batten	1800mm	13.00kg
227364	2.5m Timber Batten	2500mm	18.00kg

# Genlok System Scaffold



## Galvanised Steel Stage - Sale Only

Code	Description	Length	Weight
227386	Steel Stage - 225mm x 63mm	1300mm	6.70kg
227328	Steel Stage - 225mm x 63mm	1800mm	9.10kg
227381	Steel Stage - 225mm x 63mm	2500mm	12.40kg



## Omega Steel Batten Toeboard Clip

Code	Description	Weight
227312	OMEGA Steel Batten Toeboard Clip	1.00kg



## Omega One Board Support

Code	Description	Weight
227365	OMEGA One Board Support	1.50kg

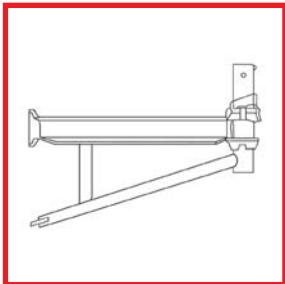

## Omega Stage Brackets

Code	Description	Length
227358	OMEGA 2 Board Stage Brackets	6.60kg
227359	OMEGA 3 Board Stage Brackets	7.60kg



# Genlok System Scaffold



## Hop-Up Bracket

Code	Description	Length
227317	2 Board Hop-Up Bracket	6.30kg
227319	2 Board Hop-Up Bracket	7.70kg



## Omega Mesh Corner Filler

Code	Description	Length
227415	2 Board OMEGA Mesh Corner Filler	9.00kg
227360	3 Board OMEGA Mesh Corner Filler	12.50kg



## Intermediate Transom

Code	Description	Width	Weight
227322	Intermediate Transom	565mm	3.70kg
227323	Intermediate Transom	795mm	5.00kg
227307	Intermediate Transom	1300mm	5.50kg
227380	Intermediate Transom	1800mm	7.30kg



## Intermediate HD Transom

Code	Description	Width	Weight
227382	Intermediate HD Transom	2500mm	16.50kg

# Genlok System Scaffold



## 1 Board Inside Board Transom

Code	Description	Length	Weight
227320	1 Board Inside Board Transom	-	9.00kg



## 2 Board Inside Board Transom

Code	Description	Length	Weight
227324	2 Board Inside Board Transom	-	11.50kg



## One Board Support

Code	Description	Weight
227354	One Board Support	1.50kg



## Return Device

Code	Description	Weight
227353	Return Device	1.50kg





# Genlok System Scaffold



## Swan Neck Standard 2m

Code	Description	Length	Weight
227426	Swan Neck Standard	2000mm	7.20kg



## Return End Blade

Code	Description	Weight
227295	Return End Blade	0.15kg



## Deck Adaptor

Code	Description	Length
228300	Deck Adaptor	1.30kg



## Handrail Post

Code	Description	Length	Weight
227329	Handrail Post	1000mm	4.90kg



# Genlok System Scaffold



## 8" Internal Spigot Rubber Castor

Code	Description	Weight
227396	8" Internal Spigot Rubber Castor	4.70kg



### Genlok Workouts - Avontus Also Available

SMART Scaffolder enables us to create easy 3D modelling, drawings, bills of material and quotations, making scaffold design faster and easier.\*

Call your nearest branch on **0800 779 7113**

Genlok System Scaffold supplied by Generation UK Ltd has been audited by the NASC and has met the criteria to satisfy the NASC Code of Practice for proprietary System Scaffold Systems.

Genlok System Scaffold has been independently tested and has met or exceeded the criteria for Quality, Technical Specification and Compliance to BS EN 12810 and BS EN 12811.





# Genlok System Scaffold - Stair Tower

Genlok System Scaffolding can be used to provide a safe, stable, site staircase enabling personnel to gain access to the working level swiftly and efficiently. Independently to other scaffolds or integral to Genlok facade scaffolds, towers can be erected with full access landings, double handrails and non-slip stair units in either steel or aluminium.

The use of Genlok Staircases on site improves safety, replacing ladders and allows multiple numbers of personnel to climb safely to their work place at one time. The most popular are a four-leg tower with a foot print of 1.8m x 3.0m and an eight leg tower with a foot print of 1.8m x 4.4m providing a full width landing at each level.

Stair units come in 1.5m and 2.0m units. 1.5m can be used where access is required to a base lift of 1.5m. Further lifts will rise at 2m increments.



### Aluminium Stair Unit

Code	Description	Weight
227412	Aluminium Stair Unit 1.5m	21.80kg
227413	Aluminium Stair Unit 2.0m	24.90kg

# Genlok System Scaffold - Stair Tower



## Steel Staircase Unit

Code	Description	Weight
227376	Steel Staircase Unit 1.5m	50.00kg
227375	Steel Staircase Unit 2.0m	65.00kg



## 8 Leg Staircase Guardrail Post c/w fitting

Code	Description	Weight
227377	8 Leg Staircase Guardrail Post c/w fitting	7.20kg



## Staircase Step Bracket

Code	Description	Weight
227425	Staircase Step Bracket	3.45kg



# Genlok System Scaffold - Stair Tower



## 4-Leg Staircases

The Genlok 4-Leg Staircase provides a compact solution with a base size of 1.8m x 3.0m, ideal for use in confined spaces.

Using fewer components it is easy and fast to erect. Additional components comprise of a Handrail Post, 0.6m, 0.9m and 3.0m Ledgers and Mesh Deck landing.



## MeshDeck (4 Leg)

Code	Description	Weight
227526	MeshDeck (4 Leg)	31.00kg



## Handrail Post

Code	Description	Weight
227329	Handrail Post	4.90kg

# Genlok System Scaffold - Stair Tower

## Loading Platforms



Genlok can be used to create Loading Towers for the purpose of distribution of pallets of materials to the working level by site forklift or loader.

The loading bay tower is built progressively with the working lifts matching that of the facade scaffold.



### Genlok Loading Bay Gate

Code	Description	Weight
227600	Genlok Loading Bay Gate	20.00kg



### Loading Bay Beam

Code	Description	Weight
227414	Loading Bay Beam	32.00kg



## Genlok System Scaffold - Stair Tower



### Loading Tower Board Bearer 2.5m

Used with scaffold boards.

Code	Description	Weight
227355	Loading Tower Board Bearer 2.5m	17.30kg



### Loading Tower Batten Bearer 2.5m

Used with Timber Battens or Steelstage.

Code	Description	Weight
227356	Loading Tower Batten Bearer 2.5m	17.30kg



## Futuro Ring System Scaffold

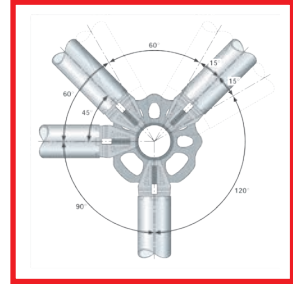

The Altrad group have been manufacturing the Futuro Ring System for over 20 years, with German engineering to the highest standards this hot dipped galvanised system meets with European standards EN12810 and EN12811-1.

Audited by the NASC, Futuro meets or exceeds the criteria to satisfy the code of practice for proprietary system scaffolds within the UK. Futuro is the ideal choice for domestic/ commercial / industrial and civil applications.

Due to the eight available connection points per optimised disc, the flexibility of this system with its in-built loading class capability and high point loading capacities makes Futuro capable of dealing with all aspects of the construction and infrastructure markets.

Utilising the galvanised steel perforated decks along with drop forged claws and integrated deck retainers the Futuro Ring System offers a range of up to eight bay lengths, this enables maximum accuracy on virtually any project.

Along with a possible saving of up to 40% on erection time against traditional tube and fitting and significant reduction in the manual handling of quantities and weights, the tubular support system benefits from using various components for multiple tasks giving a further reduction in components required on site.

Please Note:

Altrad Futuro Ring System (Tubular Support) is available for hire & sale within the UK.

Altrad Futuro U-System (U Support) is available on a sale only basis.

Please contact your nearest Altrad Generation branch for further information and availability.



### Futuro Workouts - Avontus Also Available

SMART Scaffolder enables us to create easy 3D modelling, drawings, bills of material and quotations, making scaffold design faster and easier.\*

Call your nearest branch on **0800 779 7113**

Futuro Ring System Scaffold supplied by Generation UK Ltd has been audited by the NASC and has met the criteria to satisfy the NASC Code of Practice for proprietary System Scaffold Systems.

Futuro Ring System Scaffold has been independently tested and has met or exceeded the criteria for Quality, Technical Specification and Compliance to BS EN 12810 and BS EN 12811.





# Futuro Ring System Scaffold

## Over 60% Quicker to Erect

Advanced technology; self-securing assembly eliminates the need for bolting; automatic right angles and few basic components make the erection of Futuro over 60% quicker than traditional tube and fittings. The system scaffold creates a simple, logical assembly sequence and permits the use of semi-skilled workers. By levelling the base lift you will not be required to level any further lifts. When compared to tube and fitting, whereby every time a component is added the scaffolder has to level a further 6 times. Futuro allows the same labour to erect up to 2.5 times more projects.

## Over 28% Lighter

The reduction in material weight in comparison to tube and fittings allows for faster assembly and less fatigue.

## 100% Versatile

A few basic components - standard, ledger diagonal brace and deck - form the basis for limitless use. Altrad Generation also stock an extensive range of Futuro components to cater for a scaffolders every use.

## 100% Flexible

The use of the small connection gaps for connecting horizontals allows a 90° angle to be created between them. The larger gaps allow angles between 30° and 60° allowing practically any angle to be set and shape around any construction, even in areas where access is restricted.

## 60% Less Losses

Hot-dipped galvanised steel components and the flat shape of the connection plate means no mortar, dirt, ice, grit, blasting debris etc. can accumulate ultimately allowing for a maintenance free operation.

## Simpler Storage

As well as the advantages during assembly and its high reserves of safety, the shape of the socket plates also has storage benefits. The stacked volume of the standards is about 5% smaller than other ring scaffolds and has a higher resistance to plates rolling away therefore, reducing the number of losses and potential accidents.

## Quality and Safety

High quality standards characterise the whole modular system. In-house inspection, third party supervision and the requirements of DIN EN ISO 9001, latest standard, guarantee best performance. The relevant regulations and generally recognised codes of practice must always be observed. In particular:

The British approval

BS EN12810 and BS EN12811-1

Industrial safety regulations as well as further regulations

## One System - Two Approvals

Futuro is the innovative modular scaffolding system with two approvals from the German Institut für Bautechnik, Berlin. The approval Z-8.22-841 commits the erection of the exclusive modular scaffold Futuro; the approval Z-8.22.855 regulates the erection with elements approved by Z-8.22-64. Futuro is approved in several European countries and meets all requirements of BS EN 12810.

# Futuro Ring System Scaffold

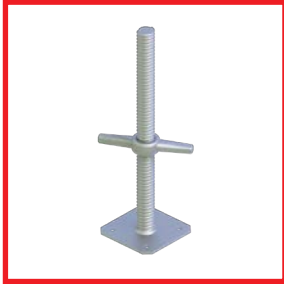

## 6 Ton Adjustable Base Jacks

Used at the base of the scaffolding for the levelling of the kicker lift in conjunction with the starting collar.

Code	Description	Weight
<b>207005</b>	6 Ton Base Jack	4.70kg
<b>207200</b>	6 Ton Swivel Base Jack	4.30kg



## 230mm Starting Collar

Used for the ease of basing out a scaffolding once placed onto the jack, this item can also be used in conjunction with twin headed hop up brackets for standard location points amongst other uses.

Code	Description	Weight
<b>591007</b>	230mm Starting Collar	1.60kg



## Vertical Standard with fixed spigot

48.3mm x 3.2mm galvanised steel tube with 8 hole connecting discs at 0.5m centres along the total length. The small openings on the connecting disc are predominantly used for ledgers & transom locations with the larger openings being used for played scaffolding and vertical braces.

Standards with the option of a bolted spigot are also available upon request.

Code	Description	Weight
<b>591000</b>	0.5m Standard (1 x Disc)	3.20kg
<b>591001</b>	1.0m Standard (2 x Disc)	5.40kg
<b>591002</b>	1.5m Standard (3 x Disc)	7.70kg
<b>591003</b>	2.0m Standard (4 x Disc)	9.90kg
<b>591005</b>	3.0m Standard (6 x Disc)	14.40kg
<b>591006</b>	4.0m Standard (8 x Disc)	18.80kg



## Futuro Ring System Scaffold



### Vertical Open-Ended Standard

48.3mm x 3.2mm galvanised steel tube with 8 hole connecting discs at 0.5m centres along the total length.

The small openings on the connecting disc are predominantly used for ledgers & transom locations with the larger openings being used for splayed scaffolding and vertical braces.

Code	Description	Weight
591021	0.5m Open Ended Standard (1 x Disc)	2.20kg
591022	1.0m Open Ended Standard (2 x Disc)	4.50kg
591023	1.5m Open Ended standard (3 x Disc)	6.70kg
591024	2.0m Open Ended standard (4 x Disc)	8.90kg
591025	2.5m Open Ended standard (5 x Disc)	11.20kg
591026	3.0m Open Ended Standard (6 x Disc)	13.40kg



### O Ledger / Transom

48.3mm x 3.2mm galvanised steel tube manufactured in a series of lengths from 0.15m - 3.07m, this component is used as a ledger / transom & guardrail.

Lengths up to 1.40m are used as deck supporting transoms due to the tubular nature of the Futuro 'O' system.

Code	Description	Weight
595148	0.15m Ledger / Double Wedge Head	1.10kg
591439	0.39m Ledger / Guardrail	1.80kg
591030	0.42m Ledger / Transom	2.00kg
591031	0.73m Ledger / Transom	3.00kg
591033	1.09m Ledger / Transom	4.10kg
591035	1.40m Ledger / Transom	5.40kg
591037	1.57m Ledger / Transom	5.60kg
591038	2.07m Ledger	7.20kg
591039	2.57m Ledger	8.80kg
591040	3.07m Ledger	10.30kg

## Futuro Ring System Scaffold

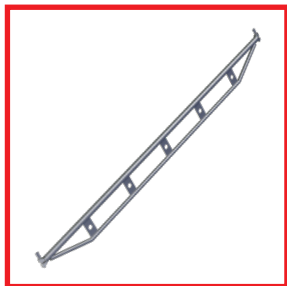

### Double Ledger / Transom (DBL) 210mm Height

This component is used when greater loadings are required or when system decks are to be supported over longer spans. Ideally used when erecting crash decks or creating cantilevered scaffolds.

Code	Description	Weight
591050	1.40m Double Ledger	8.90kg
591043	1.57m Double Ledger	9.90kg
591045	2.07m Double Ledger	13.10kg
591046	2.57m Double Ledger	16.20kg
591047	3.07m Double Ledger	19.40kg



### Double Ledger / Transom (DBL) 105mm Height

With a reduced height giving greater head clearance this component is used when greater loadings are required or when system decks are to be supported over longer spans. Ideally used when erecting crash decks or creating cantilevered scaffolds.

Code	Description	Weight
595195	1.40m Double Ledger	9.20kg
595196	2.07m Double Ledger	13.70kg
595197	2.57m Double Ledger	17.20kg



## Futuro Ring System Scaffold



### Ledger to Ledger Intermediate Transom

The intermediate transom enables the splitting of a bay in order to create an opening between decked platforms, this component locates over the ledgers between each set of standards.

This item is also used for the supporting of Timber scaffolding boards when system decks are not used.

Code	Description	Weight
<b>591049</b>	1.09m Intermediate Transom	5.10kg
<b>591415</b>	1.40m Intermediate Transom	6.20kg
<b>591051</b>	1.57m Intermediate Transom	6.80kg
<b>591559</b>	2.07m Intermediate Transom	10.30kg
<b>591416</b>	2.57m Intermediate Transom	12.50kg
<b>591560</b>	3.07m Intermediate Transom	15.00kg

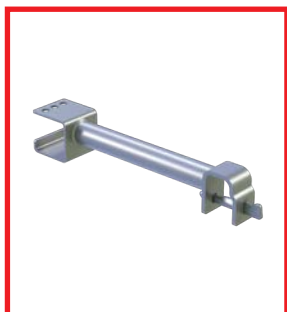

### Ledger to Deck Intermediate Transom

The ledger to deck transom allows for the creation of an opening to the side of a decked platform with one side connecting over the scaffolding ledger and the other side being connected to a steel deck. This item is often used when creating an opening for traditional ladder points through decked platforms.

Code	Description	Weight
<b>591531</b>	1 Deck Support Ledger to Deck Transom	2.70kg
<b>591532</b>	2 Deck Support Ledger to Deck Transom	3.80kg
<b>591533</b>	3 Deck Support Ledger to Deck Transom	5.00kg

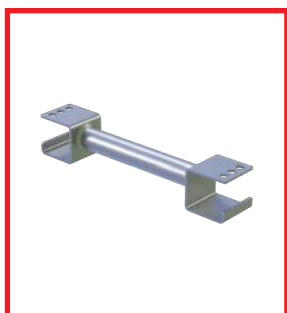

### Deck to Deck Intermediate Transom

The deck to deck transom allows for the creation of an opening in the middle of a decked platform with both ends of the transom being connected to a steel deck. Ideally used for creating openings in decked platforms for pipe work and construction support beams.

Code	Description	Weight
<b>591535</b>	1 Deck Support Deck to Deck Transom	2.30kg
<b>591536</b>	2 Deck Support Deck to Deck Transom	3.40kg
<b>591537</b>	3 Deck Support Deck to Deck Transom	4.50kg

## Futuro Ring System Scaffold



### Vertical Brace

48.3mm x 2.7mm galvanised steel tube with a swivel wedge fitting to either end, sometimes referred to as a face brace. Available to fit all bay lengths with up to 4 different height sizes.

Designed to reinforce a scaffolding structure vertically, this item can also be used for supporting scaffolding fans and the erection of cantilevered scaffolds.

Code	Description	Weight
591090	0.5m H x 2.07m L Vertical Brace	7.80kg
591089	1.0m H x 1.09m L Vertical Brace	6.00kg
591550	1.0m H x 1.40m L Vertical Brace	6.80kg
591084	1.0m H x 1.57m L Vertical Brace	7.10kg
591085	1.0m H x 2.07m L Vertical Brace	8.40kg
591086	1.0m H x 2.57m L Vertical Brace	9.80kg
591087	1.0m H x 3.07m L Vertical Brace	11.20kg
591078	1.5m H x 1.57m L Vertical Brace	8.10kg
591079	1.5m H x 2.07m L Vertical Brace	9.20kg
591080	1.5m H x 2.57m L Vertical Brace	10.50kg
591081	1.5m H x 3.07m L Vertical Brace	11.80kg
591071	2.0m H x 0.73m L Vertical Brace	8.20kg
591072	2.0m H x 1.09m L Vertical Brace	8.50kg
591073	2.0m H x 1.40m L Vertical Brace	9.00kg
591074	2.0m H x 1.57m L Vertical Brace	9.30kg
591075	2.0m H x 2.07m L Vertical Brace	10.30kg
591076	2.0m H x 2.57m L Vertical Brace	11.40kg
591077	2.0m H x 3.07m L Vertical Brace	12.60kg



## Futuro Ring System Scaffold



### Horizontal Brace (Non-Square Bay with Angled Wedge Head)

48.3mm x 3.2mm galvanised steel tube with fixed angled wedge heads to either end, used to create rigidity in the horizontal plane when decks are not required.

Also used for the basing out as this item aligns the scaffolding structure at right angles so that the bays are square, often referred to in the UK as a plan brace.

Code	Description	Weight
591096	2.57m x 1.09m Horizontal Brace	9.60kg
591100	3.07m x 1.09m Horizontal Brace	11.10kg
591540	3.07m x 1.40m Horizontal Brace	11.40kg



### Plan Brace (Square Bay with Std in-Line Wedge Head)

48.3mm x 3.2mm Galvanised Steel Tube with fixed wedge heads to either end, used to create rigidity in the horizontal plane when decks are not required.

Also used for the basing out as this item aligns the scaffolding structure at right angles so that the bays are square.

Code	Description	Weight
591106	2.57m x 2.57m Plan Brace	12.20kg



## Futuro Ring System Scaffold



### 320mm O System Ledger Deck (Standard Deck)

A high load bearing steel perforated deck, fully galvanised with drop forged connecting claws to fit 48.3mm diameter scaffolding tube. Integrated anti-lift & anti-tilt devices with a minimum 5kN/ m<sup>2</sup> working load capacity.

Code	Description	Weight
591107	0.73m x 320mm Steel Deck (class 6)	7.20kg
591108	1.09m x 320mm Steel Deck (class 6)	9.30kg
591109	1.40m x 320mm Steel Deck (class 6)	11.20kg
591110	1.57m x 320mm Steel Deck (class 6)	12.30kg
591111	2.07m x 320mm Steel Deck (class 6)	15.30kg
591112	2.57m x 320mm Steel Deck (class 5)	18.30kg
591113	3.07m x 320mm Steel Deck (class 4)	21.30kg



### 190mm O System Ledger Deck (Skinny Deck)

A high load bearing steel perforated deck, fully galvanised with drop forged connecting claws to fit 48.3mm diameter scaffolding tube. Integrated anti-lift & anti-tilt devices with a minimum 5kN/ m<sup>2</sup> working load capacity.

Code	Description	Weight
591186	0.73m x 190mm Steel Deck (class 6)	4.80kg
591114	1.09m x 190mm Steel Deck (class 6)	7.30kg
591139	1.40m x 190mm Steel Deck (class 6)	8.70kg
591115	1.57m x 190mm Steel Deck (class 6)	9.50kg
591116	2.07m x 190mm Steel Deck (class 6)	11.70kg
591117	2.57m x 190mm Steel Deck (class 5)	14.10kg
591118	3.07m x 190mm Steel Deck (class 4)	16.40kg



## Futuro Ring System Scaffold



### Alloy Ladder Deck

Full aluminium frame & deck with drop forged connecting claws to fit 48.3mm diameter scaffolding tube, complete with fully integrated drop-down ladder, 640mm wide platform will replace 2 x 320mm Steel decks.

Code	Description	Weight
591119	2.57m x 640mm Alloy Ladder Deck	29.60kg
591120	3.07m x 640mm Alloy Ladder Deck	33.30kg



### Corner Infill Deck

A galvanised steel deck that works in conjunction with the Hop-Up Bracket at a 90° internal or external corner.

Code	Description	Weight
591351	1 Board Corner Infill Deck	5.70kg
591352	2 Board Corner Infill Deck	12.30kg

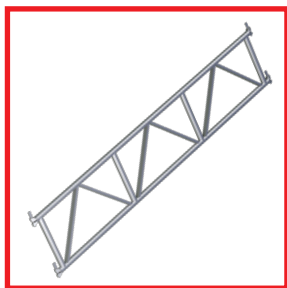

### O System 4 Wedge Head Steel Lattice Beam

Used for bridging clear spans of up to 6.14m between two sets of standards. Commonly used on system loading bays or when cantilevering out from buildings.

Code	Description	Weight
591571	2.57m x 0.5m Steel Lattice Beam 4 HD	29.70kg
595150	3.07m x 0.5m Steel Lattice Beam 4 HD	37.10kg
595135	4.14m x 0.5m Steel Lattice Beam 4 HD	49.20kg
595153	6.14m x 0.5m Steel Lattice Beam 4 HD	69.10kg

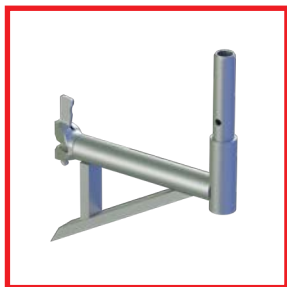

### 0.39m & 0.73m Hop Up Bracket with Spigot

Used to extend the depth of a scaffold by 1 x 320mm deck / 2 x 320mm deck. If required the spigot will then allow for the fitting of a 1m standard with 2 x 0.39m / 0.73m guardrails.

Code	Description	Weight
591179	0.39m Hop Up Bracket with Spigot	3.90kg
591420	0.73m Hop Up Bracket with Spigot	5.90kg

## Futuro Ring System Scaffold



### Hop Up Extension Bracket (190mm)

Used in conjunction with the 0.39m / 0.73m hop up bracket with spigot. The bracket slots down over the hop up bracket spigot allowing for a 190mm deck extension to be added.

Code	Description	Weight
591177	190mm Hop Up Extension Bracket	0.85kg



### Variable Hop Up Bracket (1 & 2 Deck)

Used to extend the depth of a scaffold, the variable hop-up bracket can be used as a 1 x 320mm deck or a 2 x 320mm deck support. By removing the wedge head and re-inserting in the opposite direction the bracket can very easily be adapted to do the job of two separate components.

Code	Description	Weight
591182	Variable Hop Up Bracket 1 & 2 Deck	5.60kg



### 0.73m Double Wedge Head Hop Up Bracket

Used to extend the depth of a scaffold by 2 x 320mm decks, due to having a double wedge head this item can also be used as a ledger / transom or an alloy stair flight support.

Code	Description	Weight
591181	0.73m Hop Up Bracket 2 HD	4.90kg

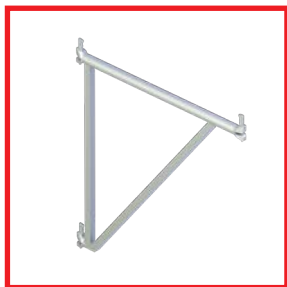

### 1.09m Cantilever Bracket

Used to extend the depth or length of a scaffold by 3 x 320mm decks, with 3 wedge heads this bracket is attached to the standards at two points with the third wedge head allowing for starting collars or vertical standards to be attached.

Code	Description	Weight
591180	1.09m Cantilever Bracket with 3 HD	9.70kg



# Futuro Ring System Scaffold



## Timber Toe Board

150mm high Timber Toe Board with galvanised steel fixing plates to either end.

Code	Description	Weight
591149	0.42m x 150mm Timber Toe Board	0.90kg
591150	0.73m x 150mm Timber Toe Board	1.60kg
591151	1.09m x 150mm Timber Toe Board	2.30kg
591152	1.40m x 150mm Timber Toe Board	2.80kg
591153	1.57m x 150mm Timber Toe Board	3.10kg
591154	2.07m x 150mm Timber Toe Board	4.10kg
591155	2.57m x 150mm Timber Toe Board	5.00kg
591156	3.07m x 150mm Timber Toe Board	5.90kg

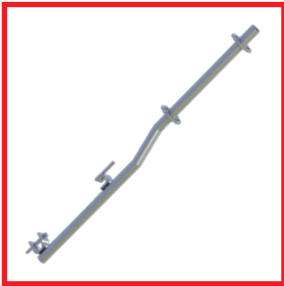

## Guardrail Post Off-Set

Used to create access points mid bay, a second ledger must be installed below the decked lift so that the post can be attached at two points. This will enable the fitting of double guardrails and a ladder safety gate.

Code	Description	Weight
591167	Guardrail Post / Ladder Gate Post Off-set	8.10kg

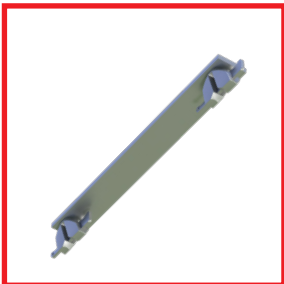

## Suspended Scaffold Connector

The Suspended Scaffold Connector is designed for bridging the connection of two standards, always used in pairs this component is ideally used when a scaffolding structure is to be suspended or craned into position. This fitting creates a positive connection to the discs either side of the joint in order to combat the tension that will be placed upon it.

Code	Description	Weight
591029	Scaffold Connector 500mm	3.00kg

# Futuro Ring System Scaffold

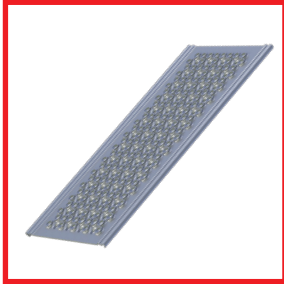

## Steel Gap Cover Plate

A perforated 320mm x 12.5mm steel plate for bridging gaps between decks of up to 140mm, this plate is held in place with the aid of over-sized plastic screw plugs.

Code	Description	Weight
<b>595157</b>	0.73m x 320mm Gap Cover Plate	2.40kg
<b>595158</b>	1.09m x 320mm Gap Cover Plate	3.40kg
<b>595159</b>	1.57m x 320mm Gap Cover Plate	5.40kg
<b>595160</b>	2.07m x 320mm Gap Cover Plate	7.40kg
<b>595161</b>	2.57m x 320mm Gap Cover Plate	9.40kg
<b>595162</b>	3.07m x 320mm Gap Cover Plate	11.40kg

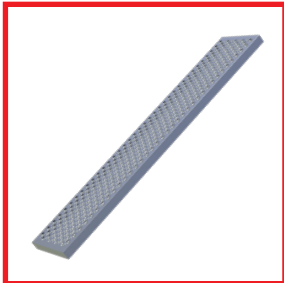

## Steel Gap Cover Deck

A perforated 320mm x 25mm steel deck for bridging gaps between decks, this plate is held in place with the aid of over-sized plastic screw plugs.

Code	Description	Weight
<b>595166</b>	1.09m x 320mm Gap Cover Deck	6.44kg



## Futuro Ring System Scaffold



### 0.15m Ledger / Double Wedge Head Fitting

Used for connecting standards together for double legged scaffolding or off setting standards in order to avoid obstructions when erecting, giving a centre to centre of standard measurement of 154mm.

Code	Description	Weight
595148	0.15m Ledger / Double Wedge Head	1.10kg



### Clampable Disc Coupler Fitting (22mm)

This fitting allows for the connection of up to six ledgers or braces at any point along a Futuro standard.

Code	Description	Weight
591440	Clampable Disc Coupler Fitting	1.10kg



### Support Spigot with Fitting (22mm)

A 300mm spigot with half coupler fitting, generally used when attached to a lattice beam or ledger to allow for the connection of a standard at any chosen point.

Code	Description	Weight
591220	300mm Support Spigot with Fitting	1.60kg

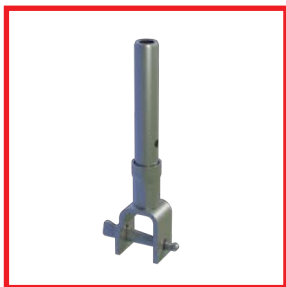

### Support Spigot with Wedge

A 300mm spigot with a wedge connection, this spigot is used to fix a standard to a steel lattice beam at pre-determined positions that are located along the top cord of the beam. Due to the wedge fitting locating through the top cord of the beam the standards are un-able to swivel at the joint.

Code	Description	Weight
591222	300mm Support Spigot with Wedge	2.10kg

## Futuro Ring System Scaffold



### Threaded Spindle with Fitting (22mm)

A 500mm adjustable spindle that enables the levelling of standards when working from un-even starting points.

Code	Description	Weight
591318	500mm Threaded Spindle with Fitting	2.90kg



### Toe Board Bracket

This fitting is attached to the standards and hooked over the toe board to enable a more permanent and secure fixing connection.

Code	Description	Weight
591430	Toe Board Bracket Fitting	1.20kg



### Wedge with Swivel Fitting (22mm)

Used for attaching traditional scaffold tube to the disc of the standard, allows the conversion of scaffolding tube into vertical braces or the tying-in of standards to ledgers on fly past returns.

Code	Description	Weight
591301	Wedge with Swivel Fitting	1.20kg



### Distance Coupler Fitting (22mm)

Used for attaching two standards together with a distance of 85mm. This fitting allows the indents of the discs on the standard to sit tight up against the other standard, with the discs being positioned at different heights.

Code	Description	Weight
591291	Distance Coupler Fitting	1.40kg



## Futuro Ring System Scaffold



### Aluminium Staircase Unit

Complete with upper and lower landings, drop forged connecting claws to fit 48.3mm diameter scaffolding tube. This 640mm wide staircase has a loading capacity of 2kM/m<sup>2</sup>.

Code	Description	Weight
591255	1.00m x 640mm Alloy Staircase	13.70kg
591256	2.57m x 640mm Alloy Staircase	30.00kg
591258	3.07m x 640mm Alloy Staircase	35.00kg

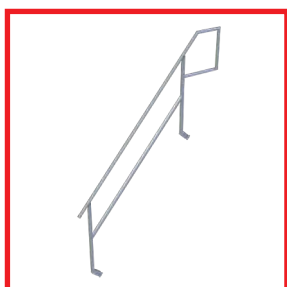

### Stair Head Guardrail (Double)

This guard rail frame is attached to the inside stringer of the top flight of stairs to create a safe fixed exit route.

Code	Description	Weight
591281	Stair Head Guardrail Frame	14.70kg

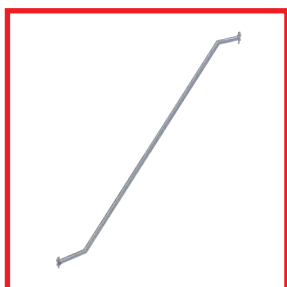

### Stair Outer Guardrail (Single Rail Option)

Two guardrails are required per staircase unit, these are fixed top and bottom to the discs of the outside standards.

Code	Description	Weight
591269	3.07m x 2m Single Outer Guardrail	13.40kg

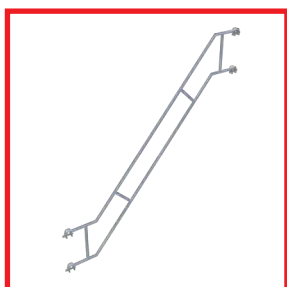

### Stair Outer Guardrail Frame (Double Rail Option)

One guardrail frame is required per staircase unit, this is attached over the landing handrails top and bottom.

Code	Description	Weight
591270	2.57m x 2.00m Double Outer Guardrail	22.80kg
591271	3.07m x 2.00m Double Outer Guardrail	25.10kg



# Futuro Ring System Scaffold

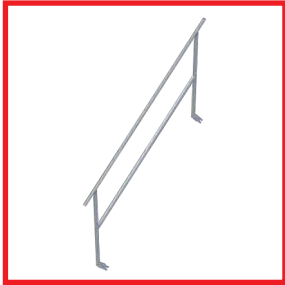

## Stair Inner Guardrail (Double)

This guard rail frame is attached to the inside stringer of each staircase unit.

Code	Description	Weight
591283	Inner Guardrail 2.57m & 3.07m x 2.00m	14.80kg

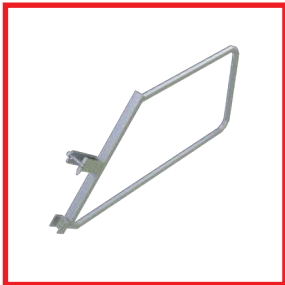

## Stair Well Guardrail Frame

This guardrail frame can be attached to the underside of a alloy staircase unit to close off the void below.

Code	Description	Weight
595184	Stair well Guardrail Frame	4.60kg

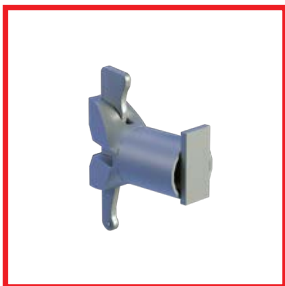

## Staircase Guardrail Adaptor

Used in pairs and attached to the outer standard of the stair tower to enable the fitting of the stair outer guardrail frame.

Code	Description	Weight
591568	Staircase Guardrail Adaptor	0.95kg



# Futuro Ring System Scaffold

## Loading Platforms

A loading tower is a reinforced scaffolding structure for the loading and storage of material and equipment whose weight would exceed the safe working load of the access scaffold to which it is connected (TG20).

Loading towers must always be designed by a competent scaffolding engineer and erected in accordance with the design and client requirements.

Altrad Generation offer a number of loading tower solutions depending upon site requirements and designer specifications.

## Futuro Tower Loading Options ~

Loading towers requiring greater capacity can be designed upon request.

6kM/m<sup>2</sup>

8kM/m<sup>2</sup>

10kM/m<sup>2</sup>

15kM/m<sup>2</sup>

## Futuro Tower Dimension Options ~

2.57m x 2.07m

2.57m x 2.57m

3.07m x 2.07m

3.07m x 2.45m

4.14m x 2.07m

4.14m x 4.14m

Please Note ~ The loading tower options above are standard weights and dimensions for more information regarding loading tower options please contact your local Altrad Generation branch.

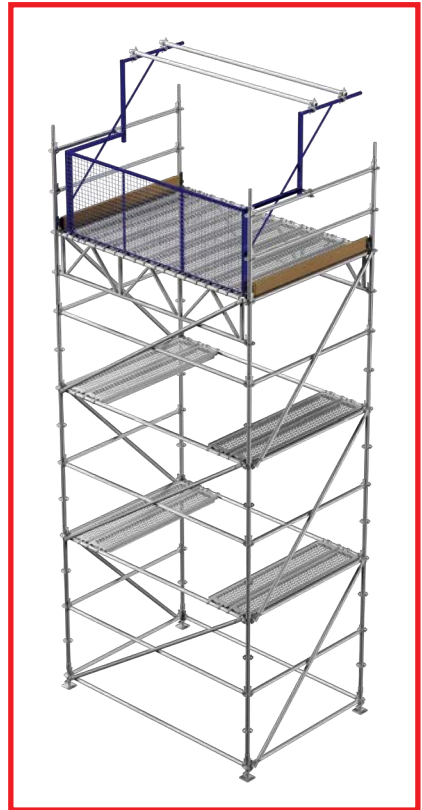



# Futuro Ring System Scaffold

## Transom Length ~ Deck Width

- 0.42m ~ 1 x 320mm
- 0.73m ~ 2 x 320mm or 1 x 640mm
- 1.09m ~ 3 x 320mm or 1 x 640mm + 1 x 320mm
- 1.40m ~ 4 x 320mm or 2 x 640mm
- 1.57m ~ 4 x 320mm + 1 x 190mm
- 2.07m ~ 6 x 320mm
- 2.57m ~ 7 x 320mm and 1 x 190mm
- 3.07m ~ 9 x 320mm or 8 x 320mm + 2 x 190mm
- 4.14m ~ 12 x 320mm and 1 x 190mm
- 5.14m ~ 15 x 320mm and 1 x 190mm
- 6.14m ~ 18 x 320mm and 1 x 190mm



# UNI Roof Temporary Roofing System

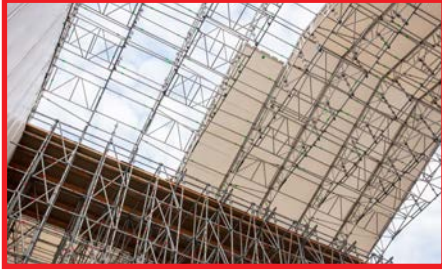

The UNI Roof Roofing System is designed for use on short to medium term temporary roofing contracts during which it will be exposed to mild or moderate weather conditions.

Using a custom made range of aluminium unit beams the roof can be erected in either mono or duo pitch configurations. If required, the system covering can be used on any type of beam.

## Versatile

- Fully modular roofing system in a range of sizes, will fit any project.
- Fits on any scaffolding system or tube and fittings, maximum on-site flexibility and stock utilisation.
- Multi-function beams with separate tracking use beams for other purposes when roof is idle.
- Mono or duo-pitch roof configurations
- From a simple roof covering to fully modular roofing system in a range of sizes will fit any project.
- Sheets can be terminated at any track joint, allows split or staggered bays and copes with over length roof beams.
- Individual bays easily opened, allows access for craned materials.
- Can be rail-mounted on steel rollers, whole sections of building can be uncovered.
- The roof bay sizes are identical to the Futuro Scaffold System for a very easy method of complete encapsulation to give a seamless integration that eliminates complicated load paths and provides a clean structural solution utilising standard components.

## Safe

- Durable PVC sheeting firmly secured in Keder tracking, safe erection from below.
- Lightweight aluminium beams and bracing, erect in situ or at height without the need for craneage.
- Superior strength and durability, proven even in the worst weather conditions.

## Simple

- Minimal number of different parts, simple logical assembly and easy stocking.
- Unique connection technology for tracking requires no couplers or pins, tracks slide into position, simple, safe and quick assembly in situ.
- Loose components eliminated, all parts snap together without bolts.

## High Performance

- Clear spans up to 60m (65m with extra design measures), exceeds most competitors.
- Unique rubber seal between tracks, seals and locates perfectly while allowing gap between tracks for sheeting termination.
- Special spring-loaded track tensioners keep roof perfectly weatherproof at all times.
- Compact ridge beam, allows tailored roof profile and reduced scaffold mass 18 degree pitch, efficient water dispersal and no ponding.

## Installation

For information on installation refer to the UNI Roof User Guide or alternatively watch our UNI Roof installation videos on Youtube by searching Altrad Generation.

Or Visit: <https://genuk.ltd/youtube>



# UNI Roof Temporary Roofing System



The use of innovative intermediate roller brace coupler makes split bays very easy to achieve together with the deeply-shrouded track spigot; this has previously been difficult if not impossible with Keder-style roof coverings.

By positioning the coupler at the end of a track section and easing open the joint, the Keder sheet on one side can be brought out of the track and terminated while retaining perfect weather-proofing. The coupler provides a housing for the roller brace, so ensuring easy sheet feeding and tensioning.

The intermediate roller brace coupler also accommodates over length beams, so that existing stocks of beams can be fully utilised. In this case the coupler is used with its built-in-track stop to retain the track sections, thereby maintaining weather resistance at the joints. This feature also allows sheeting to be pulled down the face of the supporting scaffold without excessive overhangs at the eaves. Sheeting installation is easier, as this may be done from the scaffold without the need for a special cantilever erection platform to be constructed.

The system shows another side to its versatility when complete bays are removed to allow craning of bulky materials through the roof covering.

Only one-in-five bays are fully-braced on a typical roof, the other bays being infills using only horizontal braces. In order to allow removal, the upper braces in the designated bay(s) are mounted upside-down with the tracking button facing down. This allows these braces to be removed when required to make free access through the roof.

The massive strength of the claws, with their heat-treated LM25 bodies and oversize latch pin, allow them to function in either orientation.

The system can be used as a roof covering for any available beams, although the full benefits of using custom roof beams (strength, lightness, systematic bracing intervals etc) will be lost. We have developed special ridge beams and tracks for alternative beams, including a 15 degree ridge connector which fits the majority of 45cm beams.

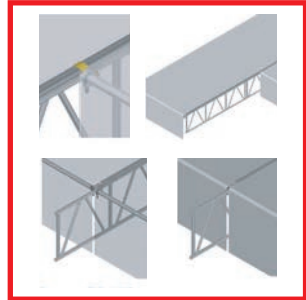

This has a bolt-on adaptor for a ridge purlin and fixing beams, allowing alternative use with other popular fixed sheet roof equipment.



# UNI Roof Temporary Roofing System



## 450mm High Capacity Alloy Beam

The Altrad Generation Aluminium 450mm Beam has been the market leader in the UK & Europe for more than 20 years. It provides significant time and cost savings across a whole range of scaffold structures.

Suspended or mobile platforms, birdcages, protection-decks bridges or temporary roofs are ideal applications for the Aluminium 450mm Beam.

The Aluminium 450mm Beam has been specifically designed to provide the highest possible UDL. The unique design allows connection directly to the node point between the diagonals, achieving maximum loading. This means, in most applications, the lowest number of beams are required. In addition, beams are quickly and simply joined together with straight connectors using fast action spring clips.

Code	Description	Length	Weight
<b>277499</b>	450mm Alloy Beam	4100mm	17.00kg
<b>277490</b>	450mm Alloy Beam	6100mm	23.00kg
<b>277500</b>	450mm Alloy Beam	8100mm	31.00kg



## D780mm Alloy Beam

Main structural component for creation of roof spans, also suitable for everyday general purpose applications. The user friendly D78 Beam range offers unrivalled cost to weight ratio and is equally at home in a heavy duty support scaffold or an elegant roofing application

- High strength, low weight and maximum versatility.
- Manufactured in traditional scaffold tube size.
- Vertical posts are provided each 1m on all beam sizes.

Code	Description	Length	Weight
<b>440004</b>	D780mm Alloy Beam	500mm	4.30kg
<b>440005</b>	D780mm Alloy Beam	1000mm	6.40kg
<b>440006</b>	D780mm Alloy Beam	2000mm	11.60kg
<b>440007</b>	D780mm Alloy Beam	3000mm	16.90kg
<b>440008</b>	D780mm Alloy Beam	4000mm	22.20kg
<b>440009</b>	D780mm Alloy Beam	5000mm	27.50kg
<b>440010</b>	D780mm Alloy Beam	6000mm	32.80kg

# UNI Roof Temporary Roofing System



## 1.33m Heavy Duty Asterix Alloy Beam

### Single Beam Lines, Massive Spans

Multiple beam lines omitted for most applications, greatly simplifies lacing and bracing, massive reduction in fittings and labour.

### Special Design, Quality Manufacture

Optimum arrangement of internal members for maximum capacity and consistent node spacing. All beams are closed end for stability and strength, spigot jointed.

### Brace with System or Tube & Fittings

Asterix HD Beam depth enables use of system UNI Frames for both plan and section bracing, meaning large beams can be braced in minutes. Alternatively, traditional tube and fittings can be used for both lacing and bracing. Unlike most other scaffold beams on the market today it is permissible to connect scaffold couplers to the posts of Asterix HD.

Permissible Moment – 102.2kN/m

Permissible Shear – 32.6kN

Code	Description	Length	Weight
<b>396055</b>	0.55m x 1.33m HD Asterix Alloy Beam	550mm	6.30kg
<b>396100</b>	1.0m x 1.33m HD Asterix Alloy Beam	1000mm	13.30kg
<b>396200</b>	2.0m x 1.33m HD Asterix Alloy Beam	2000mm	22.60kg
<b>396300</b>	3.0m x 1.33m HD Asterix Alloy Beam	3000mm	31.87kg
<b>396400</b>	4.0m x 1.33m HD Asterix Alloy Beam	4000mm	41.40kg





# UNI Roof Temporary Roofing System



## 450mm x 18 Degree Alloy Ridge Beam

Can be used to form singular 18-degree duo pitched roofs or used in multiples to create a domed structure. Normally supplied complete with 5 hole conversion spigots attached to allow for the connection of multiple 450mm alloy beam types.

Code	Description	Weight
440002	450mm x 18° Alloy Ridge Beam	6.40kg



## D780mm x 18 Degree Alloy Ridge Beam

Can be used to form singular 18 degree duo pitched roofs or used in multiples to create a domed structure. Requires D780mm 6 Hole Spigots to allow for the jointing to the beam lines.

Code	Description	Weight
440001	D780mm x 18° Alloy Ridge Beam	7.45kg



## D780mm x 36 Degree Alloy Ridge Beam

Can be used for form 36 degree duo pitched roofs to cover tall buildings. Can also be used at the eaves to form building structures and shelters.

Code	Description	Weight
440112	D780mm x 36° Alloy Ridge Beam	12.00kg



## 1.33m x 18 Degree Heavy Duty Asterix Alloy Ridge Beam

Can be used singularly to form an 18-degree duo pitch roof or used in multiples to form perfect dome structures.

Code	Description	Weight
442774	1.33m x 18° HD Asterix Alloy Ridge Beam	25.00kg



## UNI Roof Temporary Roofing System



### 450mm Beam 6 Hole Spigot

Used for connecting 450mm alloy beams, 2 x 60mm spring pins each side of the joint are required.

Code	Description	Weight
277501	450mm 6 Hole Spigot	1.19kg



### 450mm Ridge Beam 5 Hole Spigot

Used for connecting the 450mm 18-degree ridge beam to 450mm alloy beams, this spigot is normally pre bolted into the ridge beam then connected to the alloy beam with 2 x 60mm spring pins per joint.

Code	Description	Weight
440012	450mm Ridge Beam 5 Hole Spigot	1.25kg

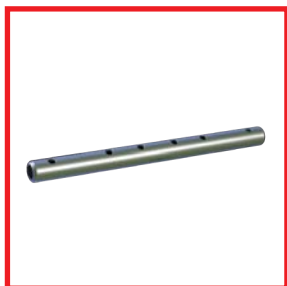

### D780mm Beam 6 Hole Spigot

Used for connecting the 450mm 18-degree ridge beam to 450mm alloy beams, this spigot is normally pre bolted into the ridge beam then connected to the alloy beam with 2 x 60mm spring pins per joint.

Code	Description	Weight
440071	D780mm Beam 6 Hole - Steel Spigot	1.49kg
440011	D780mm Beam 6 Hole - Alloy Spigot	0.80kg

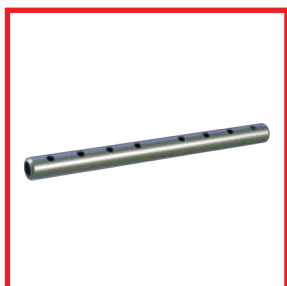

### 1.33m Heavy Duty Asterix Beam 8 Hole Spigot

Used for connecting the 1.33m 18-degree ridge beam to 1.33m alloy beams, also used for connecting 1.33m alloy beams, 4 x 60mm spring pins each side of the joint is required.

Code	Description	Weight
396900	1.33m Beam 8 Hole Spigot	1.42kg



# UNI Roof Temporary Roofing System



## UNI Frame

Fitted to the roof beam cords and to the 1.33m Asterix beam posts to provide stiffness and structural integrity. Each corner is fitted with a special tracking button that is used to secure sheet tracking in place when required.

Code	Description	Length	Weight
440017	UNI Frame	2070mm	11.22kg
440018	UNI Frame	2570mm	12.47kg
440019	UNI Frame	3070mm	13.76kg



## UNI Horizontal Brace

A single horizontal brace used for the top and bottom cord lacing and the connection of infill bays. Special button fitted to each end to enable Keder sheet tracking to be installed where required.

Code	Description	Length	Weight
442764	UNI Horizontal Brace	300mm	1.41kg
440020	UNI Horizontal Brace	2070mm	3.32kg
440021	UNI Horizontal Brace	2570mm	3.73kg
440022	UNI Horizontal Brace	3070mm	4.24kg



## UNI Diagonal Brace

Connects to the top and bottom cords of adjacent beam lines to ensure lateral stability, generally used in conjunction with UNI Frame component.

Code	Description	Length	Weight
440023	UNI Diagonal Brace 0.78m	2070mm	3.44kg
440024	UNI Diagonal Brace 0.78m	2570mm	3.94kg
440025	UNI Diagonal Brace 0.78m	3070mm	4.44kg
440026	UNI Diagonal Brace 0.45m	2070mm	3.35kg
440027	UNI Diagonal Brace 0.45m	2570mm	3.85kg
440028	UNI Diagonal Brace 0.45m	3070mm	4.37kg

# UNI Roof Temporary Roofing System



## UNI Plan Brace

Connects the posts of the adjacent beam lines providing plan stiffness, Used for bracing the 1.33m Asterix beam when used on spanning large distances or on temporary roofs. Claws are facing in opposite directions to allow easy installation and component recognition.

Code	Description	Length	Weight
442763	UNI Plan Brace 2.57m	1000mm	3.77kg
442760	UNI Plan Brace 2.57m	2000mm	4.28kg



## UNI Roller Brace

A non-structural component used to even tension applied to the sheeting when ratchet strapped into place. Connects directly into the ridge beam pocket along with the track compressor and intermediate roller brace coupler.

Code	Description	Length	Weight
442765	UNI Roller Brace	300mm	1.37kg
440029	UNI Roller Brace	2070mm	8.80kg
440030	UNI Roller Brace	2570mm	11.40kg
440031	UNI Roller Brace	3070mm	13.60kg

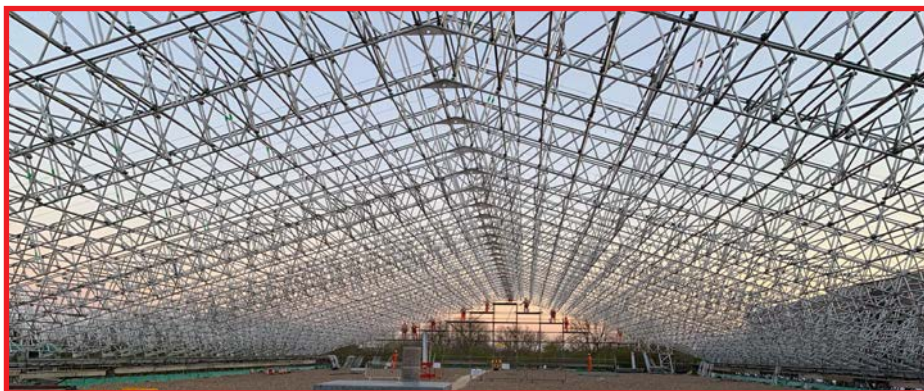



# UNI Roof Temporary Roofing System



## UNI 18 Degree Ridge Track 450mm / D78

Sheet tracking section that is connected to the 450mm / D78mm 18deg ridge beam, connected with 2 x 70mm QR pins.

Code	Description	Weight
440033	UNI Ridge Track 18° 450 / D78	2.14kg



## UNI 36 Degree Ridge Track D78

Sheet tracking section that is connected to the D78mm 18deg ridge beam, connected with 2 x 70mm QR pins, the 36deg profile allows for improved rainwater run-off.

Code	Description	Weight
440113	UNI 36° Ridge Track D78	3.62kg



## UNI 18 Degree Ridge Track 1.33m Asterix Beam

Sheet tracking section that is connected to the 1.33m 18-degree ridge beam, connected with 4 x 70mm QR pins.

Code	Description	Weight
442777	UNI 18° Ridge Track 1.33m Asterix Beam	4.53kg



## UNI Sheet Tracking

Special aluminium Keder profile supplied in variable lengths and connected using a rubber or alloy track spigot.

Code	Description	Length	Weight
440034	UNI Sheet Tracking	1000mm	1.80kg
440035	UNI Sheet Tracking	2000mm	3.50kg
440036	UNI Sheet Tracking	3000mm	5.30kg
440072	UNI Sheet Tracking	4000mm	7.10kg

## UNI Roof Temporary Roofing System



### UNI Deep Flow 18 Degree Ridge Track D78

Special aluminium Keder profile provides seamless sheeting throughout the roof lengths. Integrated spigot with a dedicated water channel along with higher profile section providing advanced weatherproofing.

Code	Description	Weight
442818	Deep Flow 18° Ridge Track D78	3.88kg



### UNI Deep Flow 36 Degree Ridge Track D78

The special aluminium Keder profile provides seamless sheeting throughout roof lengths. Integrated spigot with a dedicated water channel along with higher profile section provides advanced weatherproofing.

Code	Description	Weight
442836	Deep Flow 36° Ridge Track D78	5.97kg



### UNI Deep Flow 18 Degree Ridge Track 1.33m Asterix

Special aluminium Keder profile provides seamless sheeting throughout the roof lengths. Integrated spigot with a dedicated water channel, along with higher profile section providing advanced weatherproofing.

Code	Description	Weight
442817	Deep Flow 18° Ridge Track 1.33m Asterix	6.53kg



### UNI Deep Flow Sheet Tracking

Integrated spigot with a dedicated water channel, along with higher profile section providing advanced weatherproofing.

Code	Description	Length	Weight
442801	Deep Flow Sheet Tracking	1000mm	2.65kg
442802	Deep Flow Sheet Tracking	2000mm	5.23kg
442803	Deep Flow Sheet Tracking	3000mm	7.82kg
442804	Deep Flow Sheet Tracking	4000mm	10.44kg



# UNI Roof Temporary Roofing System



## UNI Deep Flow 1m End Piece With Spigot

Special colour coded end piece for easy recognition. Required at the top end of Mono pitched roofs when used in conjunction with track compressors.

Code	Description	Length	Weight
442809	Deep Flow End Piece w. Spigot	1000mm	2.60kg



## UNI Deep Flow 1m End Piece No Spigot

Special colour coded end piece for easy recognition. Required at the eaves of Mono and Duo pitched roofs used in conjunction with track compressors.

Code	Description	Length	Weight
442808	Deep Flow End Piece No Spigot	1000mm	2.58kg



## UNI Roof Track Compressor

Used at the end of D780mm / 1.33m Asterix alloy beam lines to secure sheet tracking. Maintains 100kg of track compression and allows for the installation of the roller braces, fixed in place with 1 x 60mm spring pin.

Code	Description	Weight
440125	UNI Roof Track Compressor	1.55kg

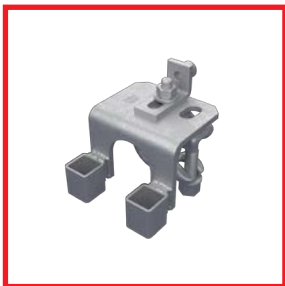

## Intermediate Roller Brace Coupler

Used at the end of the Altrad Generation 450mm alloy beam lines to secure sheet tracking. Also used to create staggered bays along with the installation of roller braces.

Code	Description	Weight
440043	Intermediate Roller Brace Coupler	1.45kg

# UNI Roof Temporary Roofing System

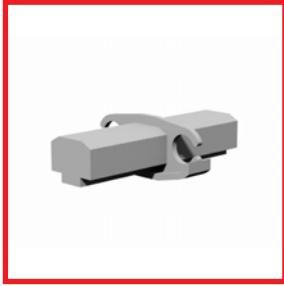

## UNI Sheet Track Rubber Spigot

Used to create a seal when using standard UNI sheet tracking.

Code	Description	Weight
440037	UNI Sheet Track Rubber Spigot	0.09kg



## UNI Sheet Track Alloy Spigot

Ensures joint stability between sheet tracking lengths and provides an efficient seal between adjacent track lengths.

Code	Description	Weight
440128	UNI Sheet Track Alloy Spigot	0.26kg



## UNI Roof Sheeting Ratchet Straps

Enables sheets to be tensioned and to be connected to the scaffolding structure.

Code	Description	Weight
440045	Roof Sheeting Ratchet Strap 460kg	0.48kg
440046	Roof Sheeting Ratchet Strap 1000kg	0.52kg

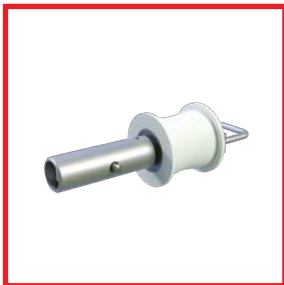

## UNI Detachable Sheet Tension Bar Wheel

Engages with the sheet tensioning bar, nylon wheels are to be located over the sheet tracking to enable the installation of the sheeting. To be removed after sheet installation and used on the next bay.

Code	Description	Weight
442766	UNI Detachable Sheet Tension Bar Wheel	1.51kg



# UNI Roof Temporary Roofing System



## UNI Sheet Pulling Bar Wheel

Used to aid with the process of sheeting roofing structures, the nylon wheels can be adjusted to fit each bay size and run along the length of the sheet tracking.

Code	Description	Weight
440041	UNI Sheet Pulling Bar Wheel	8.20kg



## UNI Sheet Tensioning Bar

Special tube lengths to be used in the ends of each roof sheet to enable installation and tensioning, additionally to form a continuous tube at the eaves. Works in conjunction with the detachable tension wheel.

Code	Description	Length	Weight
442768	UNI Sheet Tensioning Bar	300mm	0.79kg
440038	UNI Sheet Tensioning Bar	2070mm	7.39kg
440039	UNI Sheet Tensioning Bar	2570mm	9.26kg
440040	UNI Sheet Tensioning Bar	3070mm	11.13kg



## UNI Eaves Continuous Tube Connector

Used at the end of the Altrad Generation 450mm alloy beam lines to secure sheet tracking. Also used to create staggered bays along with the installation of roller braces.

Code	Description	Weight
442780	Alloy Continuous Eaves Connector	0.75kg
-	Steel Continuous Eaves Connector	1.11kg



# UNI Roof Temporary Roofing System

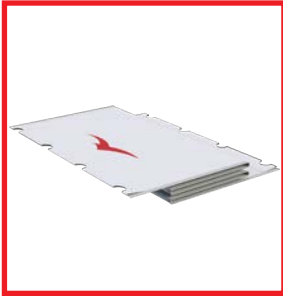

## UNI Roof Heavy Duty 610gsm FR Sheeting

Fabric-based heavy duty flame retardant 610gsm sheeting with 8mm Keder to suit installation into UNI roof sheet tracking, three years anti-yellowing / anti-mildew capability and allowing high levels of light to penetrate the roofing structure.

FR BS 7837 TEST 5438/B2  
FR-DIN 4102, B1-PASS  
BN EN 13501-1 B,S2,D1  
Standard widths ~ 2.07m / 2.57m / 3.07m  
Made to measure gable end sheeting also available.

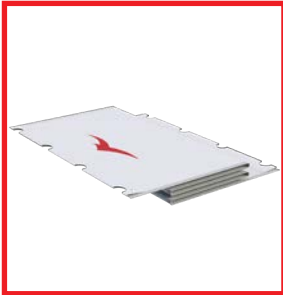

## UNI Roof Standard 300gsm Sheeting

PVC coated polyester scrim based sheeting 300gsm with an 8mm Keder to suit installation into UNI roof sheet tracking, translucent in colour allowing for high levels of light to penetrate the roofing structure.

BS 7955  
Standard widths ~ 2.07m / 2.57m / 3.07m

Please contact your local Altrad Generation supplier for a full listing of available widths and lengths.





## UNI Roof Temporary Roofing System



### Ridge Track QR Pin M12 x 70mm Square

Used to connect alloy ridge tracks to the UNI Roof ridge beams.

Code	Description	Weight
440016	Ridge Track QR Pin M12 x 70mm Square	0.10kg



### Beam spigot 60mm Spring Clip

Used to fix beam spigots in place when creating beam lines.

Code	Description	Weight
277631	Spring Clip 60mm	0.07kg



### M12 x 60mm Bolt & M12 Nyloc Nut

Bolt – Used along with M12 Nyloc nut as an alternative to the 60mm spring pin.

Nut – Used along with M12 x 60mm bolt as an alternative to the 60mm spring pin.

Code	Description	Weight
440013	Beam Spigot M12 x 60mm Bolt	0.06kg
440014	Beam Spigot M12 Nyloc Nut	0.05kg

## UNI Roof Beam Supports



<b>D Code</b>	<b>AA0007</b>
<b>AG Code</b>	<b>440107</b>
<b>Desc.</b>	Beam Support Upright
<b>Wt.</b>	11.28kg
<b>Dim 1</b>	1050mm
<b>Dim 2</b>	250mm

Compatible with our castors, sysTRAX sliding supports our range of connector plates, this support spur, in conjunction with AA0008 and AA0009 allows for simple construction of telescopic mobile roofs.



<b>D Code</b>	<b>AA0008</b>
<b>AG Code</b>	<b>440108</b>
<b>Desc.</b>	Beam Support Spur Inner
<b>Wt.</b>	3.06kg
<b>Dim 1</b>	670mm
<b>Dim 2</b>	110mm

This inner spur is used in conjunction with outer spur AA0009 and allows the spur to be located at various locations on the beam bearer.



<b>D Code</b>	<b>AA0009</b>
<b>AG Code</b>	<b>440109</b>
<b>Desc.</b>	Beam Support Spur Outer
<b>Wt.</b>	3.95kg
<b>Dim 1</b>	760mm
<b>Dim 2</b>	110mm

This outer spur is used in conjunction with inner spur AA0008 and allows the spur to be located at various locations on the beam bearer.

## Gutter Bracket

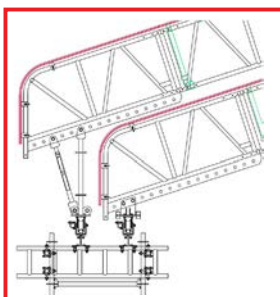

Secures 38x225mm timber scaffold boards allowing for installing of proprietary rainwater management goods at the eaves of temporary roof.

<b>Code</b>	<b>Description</b>	<b>Dim 1</b>	<b>Dim 2</b>	<b>Weight</b>
<b>UA0038</b>	Gutter Bracket	310mm	570mm	7.10kg

\*These are special products, contact us for more information.



# Estimating Software

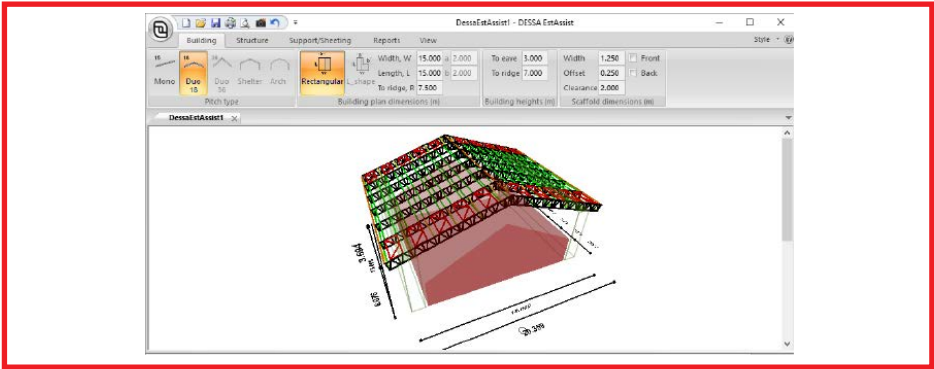

3D estimating software for all DESSA Roof Systems, allows quick material lists and quotations to be generated and facilitates easy and simple changing of roof length, span, bay size and supports.  
Windows 10 compatible.

Extensive industry experience at management level as well as within the design team places DESSA in an excellent position for its clients. DESSA offers a full design and check service covering scaffold projects, temporary roofing projects and bespoke product design. This service is backed up with site visits when required and not limited to DESSA products, other proprietary systems and temporary works designs can be also checked.

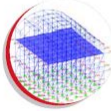

- At DESSA we take full advantage of state of the art engineering software:
- Autodesk Product Design & Manufacturing Collection (includes: AutoCad, AutoCad Mechanical, Inventor, 3ds Max)
  - Graltec visual analysis software, full frame 3D.
  - Sketchup
  - Adobe Creative Cloud (Photoshop, InDesign, After Effects, Premiere Pro)

### WE ARE PROUD TO OFFER:

- 2D design drawing creation / submissions / checking
- 3D visuals
- Animations / Training videos
- 2D/3D Structural Frame Analysis complete with calculation reports
- Method Statements / Risk Assessments
- Site visits / Inspections / Approvals

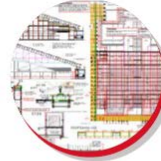

### Innovative & Bespoke Concept development

- Needs analysis
- Fabrication drawings
- 3D visuals
- 2D/3D Structural Frame Analysis complete with calculation reports
- Prototyping / Launch

- Full support for system scaffolds / lattice beams / access products
- Compliance checking / testing
- Technical literature support / maintenance
- Commercial / Technical proposals



Watch our UniRoof installation videos on YouTube by searching Altrad Generation



- Conduct tailored training courses for bespoke customer requirements
- Optimal combination of classroom and practical workshops
- Follow up testing
- On site training
- Software training
- Instructional videos

# Temporary Roof Sheeting



## Powerclad® Keder 2000 FR

- Made to customer requirements to fit any modular Keder roof system.
- High tensile strength woven polyester multifilament yarn.
- Double-sided waterproof coating with smooth flat finish.
- Excellent low-temperature characteristics.

Weight	Widths	Keder Rod Dia.	Tensile Strength	Flame Retardant
<b>610gsm</b>	2.07m/ 2.57m/ 3.07m Systems	8mm, 9mm, 10mm	Wrap 2,000 N/50mm Weft 2,000 N/50mm	BS476 Part 12c BS 5867 Part 2B DIN 4102 B1



## Powerclad® Keder 1215 FR

- Made to customer requirements to fit any modular Keder roof system.
- High tensile strength woven tape yarn.
- Double-sided waterproof coating with smooth flat finish.
- Excellent low-temperature characteristics.
- Environmentally friendly.
- Colour printing available.

Weight	Widths	Keder Rod Dia.	Tensile Strength	Flame Retardant
<b>300gsm</b>	2.07m/ 2.57m/ 3.07m Systems	8mm, 9mm, 10mm	Wrap 1,100 N/50mm Weft 1,100 N/50mm	LPS 1215 BS 476 Part 12C BS 5867 Part 2B DIN 4102 B1



## Powerclad® Keder 1100

- Made to customer requirements to fit any modular Keder roof system.
- High tensile strength woven tape yarn.
- Double-sided waterproof coating with smooth flat finish.
- Excellent low-temperature characteristics.
- Environmentally friendly.
- Colour printing available.

Other widths and lengths are available to order.

Weight	Widths	Keder Rod Dia.	Tensile Strength	Flame Retardant
<b>300gsm</b>	2.07m/ 2.57m/ 3.07m Systems.	8mm, 9mm, 10mm	Wrap 1,100 N/50mm Weft 1,100 N/50mm	-



# Temporary Roof - Trax UB

## Anti-uplift track system for rolling temporary roofs

Roll-out erection method for temporary roofs using Trax UB can eliminate all work at height relying on the use of a harness. The Trax UB anti-uplift track system for rolling temporary roofs provides a fast and easy way of opening roofs for craning through materials and plant. Even large span roofs can be opened and closed with minimal effort in minutes. Mobile roofs also show great advantages in progressive works avoiding the need to strike and re-erect. The built-in permanent anti-uplift feature allows safe erection even in windy weather. Simple locking screws firmly secure the castors to the track when movement is not required. Trax UB provides a fast and easy way of opening roofs for craning through materials and plant, even large span roofs can be opened and closed with minimal effort in minutes. Mobile roofs also show great advantages in progressive works avoiding the need to strike and re-erect.



### Trax Tube Bracket

Allows scaffolding tube to form an effective track for the rolling of scaffolding structures and temporary roofs. To be fixed every 2m by bolting or screwing down to traditional timber scaffolding boards. A cost-effective way to assemble and dismantle structures from a safe working platform, this system does NOT have any anti-up-lift capability.

Code	Description	Weight
440120	Trax Tube Bracket	1.30kg



### Trax UNI Beam

Steel beams with integrated tubing element secured to scaffolding transoms with the boltless girder clamp (440104), full anti-up-lift capability at all times. Must be supported 1.2m max.

Code	Description	Length	Weight
440101	Trax UNI Beam 2m	2000mm	40.00kg
440102	Trax UNI Beam 3m	3000mm	60.00kg
440103	Trax UNI Beam 4m	4000mm	80.00kg

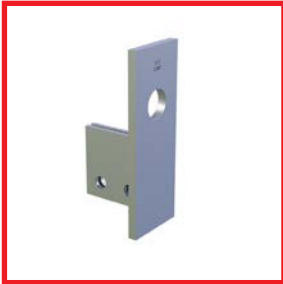

### UNI Beam End Closer

Effective stop end for the Trax UNI beam, this device ensures that the rolling structure remains captive at all times.

Code	Description	Weight
440099	Trax UB Beam End Closer	2.60kg

## Temporary Roof - Trax UB

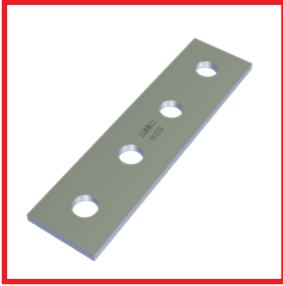

### Trax UB Beam End Joint Plate

Used to join adjacent lengths of Trax UNI beam using 4 x M16 x 40mm bolts and nuts. Two plates per joint are required. Joints must be supported within 150mm either side.

Code	Description	Weight
440100	Trax UB Beam End Joint Plate	2.60kg

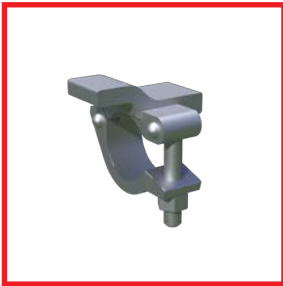

### Boltless Girder Clamp

Connects to existing 48.3mm scaffolding tubular transoms to secure Trax UNI beam in place. Girder clamps are to be used in pairs at 1.2m centres max and within 150mm either side of beam joints.

Code	Description	Weight
440104	Boltless Girder Clamp	1.10kg

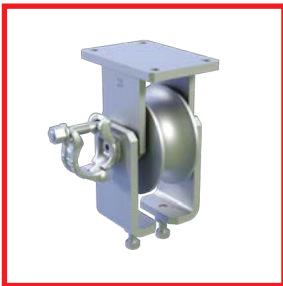

### Trax Anti Uplift Castor Body

Heavy-duty rolling castor unit that offers the full anti-up-lift capability for scaffolding structures and temporary roof systems. The castor is used in conjunction with a range of top plates to enable various types of connection.

Code	Description	Weight
440108	Trax Anti Uplift Castor Body	15.00kg



### Universal Castor Attachment

Enables standard scaffolding tube connections, secured using 3 half couplers. Top plate to be fixed to castor with 4 x M12 x 45mm bolts and nuts.

Code	Description	Weight
440109	Universal Castor Attachment	3.40kg



# Temporary Roof - Trax UB



## Castor Top Plate with D78 Beam Spigot

Enables direct connection to D78mm alloy beams, fixed in place with 2 x 60mm spring pins. Top plate to be fixed to castor with 4 x M12 x 45mm bolts and nuts.

Code	Description	Weight
440114	Castor Top Plate with D78 Beam Spigot	3.40kg



## Castor Top Plate 0 Degrees

Provides a 0-degree connection to the structure when used in conjunction with the D78 Beam Bearer (440130). Top plate to be fixed to castor with 4 x M12 x 45mm bolts and nuts.

Code	Description	Weight
442782	Castor Top Plate 0 Degrees	5.00kg



## Castor Top Plate 18 Degrees

Enables an 18-degree connection to the roof structure when used in conjunction with the D78 Beam Bearer (440130) and the 1.33m Asterix Beam Bearer (442771). Top plate to be fixed to castor with 4 x M12 x 45mm bolts and nuts.

Code	Description	Weight
442769	Castor Top Plate 18 Degrees	5.20kg



## D78 Beam Bearer 700mm with 4 x Coupler

Enables the connection of a scaffold or roofing structure to the castor top plates. Fixed into position with 2 x beam bearer 30mm locking pin (440141) and 2 x Linch pin (440143).

Code	Description	Weight
440130	D78 Beam Bearer 700mm w. 4 x Coupler	7.30kg



## Temporary Roof - Trax UB



### 1.33m Asterix Beam Bearer 2m

High capacity connection of scaffold or roof structure to support elements. Eliminates local buckling effects and ensures even load distribution. Connects to a 2m x 1.33m Asterix alloy beam using 2 x beam bearer connection brackets (442770).

Code	Description	Weight
442771	1.33m Asterix Beam Bearer 2m	23.67kg



### Beam Bearer Connection Bracket

Enables the connection of 2m beam bearers to the 1.33m Asterix beam, each bearer is fixed into position with 4 x M12 x 90mm bolts/nuts. Lower cord beam spigots are to be inserted at the same time as the bracket.

Code	Description	Weight
442770	Beam Bearer Connection Bracket	3.33kg



### UNI Beam M16 x 40mm Bolt / Nut

Used to attach UNI beam jointing plates, 4 x bolt/nut per joint.

Code	Description	Weight
440105	UNI Beam M16 x 40 Bolt	0.03kg
-	UNI Beam M16 Nut	0.05kg

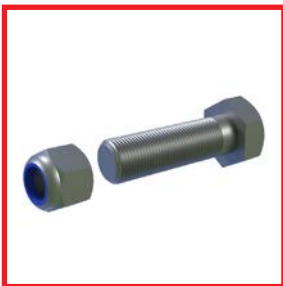

### Castor Top Plate M12 x 45mm Bolt

Used to attach castor top plates to Trax anti-uplift castor body, 4 x bolt/nut per top plate.

Code	Description	Weight
440013	M12 x 45 Bolt	0.05kg
440014	M12 Nyloc Nut	0.05kg



## Temporary Roof - Trax UB



### M12 x 90mm Bolt Nut

Used to attach castor top plates to Trax anti-uplift castor body, 4 x bolt/nut per top plate.

Code	Description	Weight
440140	M12 x 90 Bolt	0.09kg
440014	M12 Nyloc Nut	0.05kg



### Beam Bearer 30mm Locking Pin

Used to connect beam bearers to castor top plates and beam bearer connection brackets to the 2m beam bearer.

Code	Description	Weight
440141	Beam Bearer 30mm Locking Pin	0.55kg



### Beam Bearer M6 Linch Pin

Used to connect beam bearers to castor top plates and beam bearer connection brackets to the 2m beam bearer.

Code	Description	Weight
440143	Beam Bearer M6 Linch Pin	0.02kg

# Temporary Roofing - Trax Bracket



The purpose of the Trax bracket is to provide a cost effective, quick and efficient method for rolling out beam assemblies, gantries or temporary roofs.

Trax brackets are designed to be used with either 3.2mm or 4mm scaffold tube and can be screwed to a 225mm width scaffold boards using 8/10mmx40 coach screws, timber screws with washers or similar, they may also be secured to concrete, plywood or other load bearing platform.

**The following spacing's are recommended:-**

For horizontal gantries, beam assemblies and roofs.	3m c/c
For sloping structures i.e. temporary roofs	2m c/c

Before assembly it is necessary for the load bearing capacity of the platform supporting the Trax brackets and tube to be verified.

If horizontal loads are expected boards should be restrained by means of board clamps or similar and all Trax bracket fixings should again be verified.

The Trax brackets and tube together form a runway system using the rolling roof wheels, this system does not provide any uplift up capability and therefore must NOT be used to move any sheeted temporary roofs or structures which may be affected by uplift of wind. Once in position, roofs should be tied down to an appropriate system of bracing.

No stop end plates are provided so tube butts or band and plate fittings should be provided to stop the mobile structure from rolling too far.

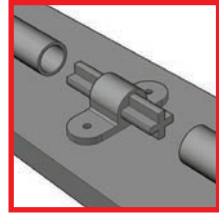

440120

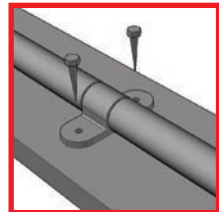
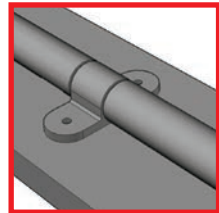

440108



# Altrad Generation Stair Tower

The Altrad Generation Stair Tower, available for both hire and sale, provides safe, speedy access to the working level through a series of 800mm wide purpose built stairways.

Fully galvanised with landings every 1.0m / 1.5m / 2.0m. The stair tower enables movement of personnel swiftly and safely to the work place. Handrails are automatically positioned at the correct height for safe and convenient use. Stair treads and landings are manufactured from expanded steel ensuring a safe slip resistant surface.

The Stair Tower can be built as a separate construction or integrated into other scaffolding or staging.

Footprint size 3.05m x 1.655m



**Stairtower Workouts**  
Altrad Generation staff can quickly calculate each tower requirement using our computer aided estimating software.  
Call your nearest branch on  
**0800 779 7113**

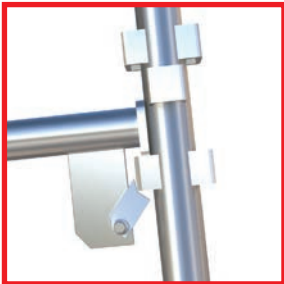

**Fully Locking Components**



**Safe Access From First Step**

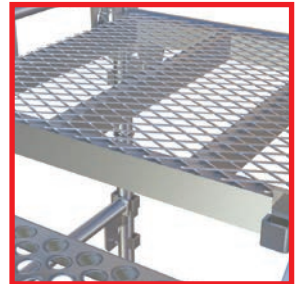

**Safe Non-slip Landing Platforms**

The Altrad Generation Stair Tower has been audited by the NASC and has met the criteria to satisfy the NASC Code of Practice for proprietary System Scaffold Systems.

Generation Stair Tower has met or exceeded the criteria for Quality, Technical Specification and Compliance to BS EN 12810 and BS EN 12811.



# Altrad Generation Stair Tower



## Adjustable Base Jack

Code	Description	Weight
207005	Adjustable Base Jack	4.70kg



## Ledger Beam

Code	Description	Length	Weight
277409	Ledger Beam	3000mm	17.00kg



## Guard Rail Post

Code	Description	Weight
277477	Guard Rail Post	11.00kg



## Clip on Guard Rail Post

Code	Description	Weight
277550	Clip on Guard Rail Post	5.80kg



# Altrad Generation Stair Tower



## Advance Guard Rail Tool

Code	Description	Weight
277433	Advance Guard Rail Tool	1.50kg



## Folding Guard Frame

Code	Description	Weight
277479	Folding Guard Frame	9.20kg



## Guard Rail Frame

Code	Description	Weight
277478	Guard Rail Frame	9.20kg



## Side Toe Board

Code	Description	Weight
278122	Side Toe Board	3.00kg

# Altrad Generation Stair Tower



## Entrance Step

Code	Description	Weight
277426	Entrance Step	13.40kg

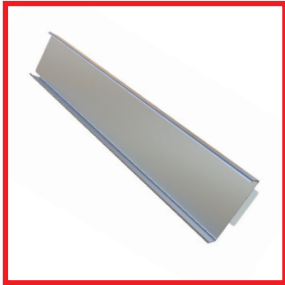

## Top Toe Board

Code	Description	Weight
278123	Top Toe Board	3.20kg



## End Toe Board

Code	Description	Weight
278121	End Toe Board	5.20kg



## Guard Rail (Single)

Code	Description	Length	Weight
277418	Guard Rail (Single)	3000mm	10.40kg
277469	Guard Rail (Single)	2160mm	8.00kg



# Altrad Generation Stair Tower



## Standards

Code	Description	Length	Weight
277403	Standards	3000mm	17.80kg
277404	Standards	2000mm	12.00kg
277406	Standards	1000mm	6.00kg



## Guard Rail Frame

Code	Description	Length	Weight
277476	Guard Rail Frame	3000mm	14.60kg
277645	Guard Rail Frame	1600mm	10.20kg

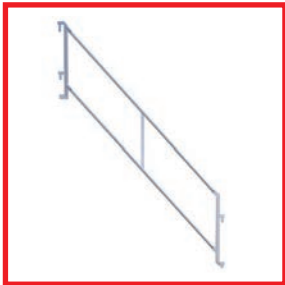

## Stair Guard Rail

Code	Description	Length	Weight
277414	Stair Guard Rail	2000mm	13.80kg
277415	Stair Guard Rail	1500mm	12.50kg
277421	Stair Guard Rail	1000mm	10.50kg



## Stair Flight

Code	Description	Length	Weight
277427	Stair Flight	2000mm	43.00kg
277428	Stair Flight	1500mm	33.50kg
277425	Stair Flight	1000mm	28.00kg



# Altrad Generation Stair Tower



## Stage Landing

Code	Description	Weight
277432	Stage Landing	27.70kg

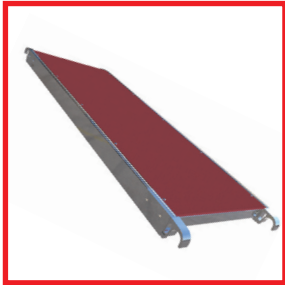

## Erection Platform

Code	Description	Weight
277480	Erection Platform	15.00kg



## Single Tube Beam

Code	Description	Length	Weight
277815	Single Tube Beam	1600mm	7.00kg



## Ranger™ Stair

The Ranger™ Stair is a range of self-contained, pre-assembled aluminium stair units, flat packed, which automatically adjust to a wide range of lift heights, making them ideal for use in tube and fitting scaffolds along with other applications. The Ranger™ Stair is fully compliant with BS EN12811 for all possible configurations.

Code	Description	Weight	Minimum Height (mm)	Maximum Height (mm)
<b>278301</b>	Ranger™ Stair, 3 Tread	18.49kg	557	783
<b>278302</b>	Ranger™ Stair, 6 Tread	29.66kg	985	1457
<b>278303</b>	Ranger™ Stair, 9 Tread	40.71kg	1412	2130
<b>278304</b>	Ranger™ Stair, 12 Tread	51.92kg	1840	2804
<b>278305</b>	Ranger™ Stair, 15 Tread	62.91kg	2267	3478
<b>278309</b>	Ranger™ Stair, 18 Tread	87.80kg	2690	4146

### Stair Assemblies

Description	Guardrail Mini	Guardrail Short	Guardrail long
Ranger™ Stair, 3 Tread	2	-	-
Ranger™ Stair, 6 Tread	-	2	-
Ranger™ Stair, 9 Tread	-	-	2
Ranger™ Stair, 12 Tread	-	4	-
Ranger™ Stair, 15 Tread	-	2	2
Ranger™ Stair, 18 Tread	-	-	-



### Guardrail Units

Code	Description	Weight
<b>278310</b>	Ranger™ Guardrail Mini	5.21kg
<b>278307</b>	Ranger™ Guardrail Short	5.90kg
<b>278306</b>	Ranger™ Guardrail Long	7.30kg

### Connectors

Code	Description	Weight
<b>Inc. with Stair</b>	Tube Connector Left	1.36kg
<b>Inc. with Stair</b>	Tube Connector Right	1.36kg
<b>278308</b>	Slab Connector Left	1.38kg
<b>278308</b>	Slab Connector Right	1.38kg

## Layher Allround® Scaffolding



The proven combination of positive and non-positive connections in a rapid and bolt-free system technology with AutoLock function facilitates connections that are automatically right-angled, obtuse-angled and acute-angled – and ensures built-in safety at the same time. Layher Allround® Scaffolding has now become synonymous with modular scaffolding on the market. Since its launch in 1974, this original system has been undergoing continuous development and offers an impressive variety of uses, on any construction site, in industry, chemical plants, power stations, shipyards and for events. As scaffolding for working, protection, façade work or support, as internal or birdcage scaffolding.

Even with very difficult layouts and architecture styles and with heightened safety requirements, Layher Allround® Scaffolding offers a fast, safe and economical solution.

### **Fast.**

The lighter components increase the speed of assembly and also transport capacities – that saves real money.

### **Strong.**

Increased loading capacity despite lower weight.

### **Safer.**

Improved occupational safety during assembly thanks to the AutoLock function.

### **Ergonomic.**

Increased height clearance and reduction of physical strain by saving up weight in the system.

### **Efficient.**

Only one standard for supported and suspended scaffolding thanks to integrated spigots. There is no need for time-consuming installation of separate spigots or storage of two different standards.

### **Compliant.**

Is fully audited by the NASC for quality, Technical Specification and satisfies the NASC Code of Practice for proprietary system scaffolds, complying to BS EN 12810 and BS EN12811



## Layher Site Stair Tower



Our Layher stair tower system range is available to provide a range of load bearing capabilities, with safety and versatility key benefits. Simply assembled, almost any application requirement can be met – from lifts shafts and compact spaces to site stairs and public access facilities. In all cases, stairtower selection benefits from a choice of purpose-designed accessories and additional features that enhance site efficiency and performance.

### Standard Site Stair tower

- Permissible Load 2.5kN/m<sup>2</sup>
- Aluminium Stair
- Can be erected in parallel and alternating directions
- Normal base sizes 2.57m x 1.4m or 3.07m x 1.4m
- Available in 2m and 1.5m lifts with option of Modular Stair Attachments
- Easy to handle and install, conforming to manual handling regulations



# Notes

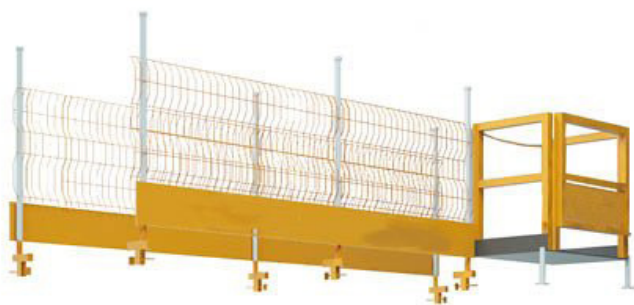

# Groundworks

Services

Trench Boxes

Drag Boxes

Manhole Boxes

Trench Box Safety Ancillaries

Alloy Water Rails

Standard Hydraulic Manhole Brace

Mammoth Plus

Trench Sheeting

Groundwork Ancillaries

Ground Protection

Roadforms

Additional Services





## Groundworks



Altrad Generation supplies excavation safety solutions to the construction industry. We work with you to ensure you have the right temporary groundworks equipment, independent design and implementation for your project. Our groundworks support equipment will help you save time, lower costs, and ultimately remove safety risks. We have everything you need to get that first stage of your project completed safely and on time. So, whether you need groundworks support for trenching, or a more complex sheet and bracing system for that deep excavation, we have the expertise to design and supply you with the correct equipment delivered on time.

### Why Choose Us?

#### Who do we supply groundworks products and services to?

We support large, small, and local organisations across multiple sectors. These range from local contractors, national contractors, temporary work teams and architects. Our technical expertise and equipment are deployed across a broad range of projects, that are integral to maintaining and building the UK's vital infrastructure, involving schools, hospitals, roads, railways, and energy supply. Please ask about our involvement in the new High-Speed Network, CP6 and AMP7.

We also supply national/regional contractors engaged in many of the water frameworks such as Scottish Water, United Utilities, Welsh Water, Severn Trent, Tendering, Thames Water, Yorkshire Water and Anglian Water.

#### Groundworks Equipment

Our impressive range of groundworks products includes:

- All Trench, Drag and Manhole boxes, including lightweight ranges that offer cost savings to the customer, reducing the need for large machines on-site.
- Large hydraulic brace systems ranging from 1.60m – 25.00m+ to suit any type of excavation.
- Hydraulic waler range to suit all sizes, depths and lengths of trench.
- Comprehensive range of trench sheets and steel sheet piles.
- Road Forms and Road Plates
- Complete Independent Temporary Design Works Design Service
- Transport, access to a large fleet of our own FORS Silver vehicles and up to FORS Gold external transport partners





## Groundworks

### Rigorous Testing

As part of our ISO 9001 accreditation, we routinely and rigorously test all of our equipment and provide full life history of all products such as boxes and all hydraulics. All our groundworks depots are equipped with a state of the art hydraulic testing rig that provides 'Back Pressure' of up to 120t to simulate the real life stresses exerted upon the hydraulics when in situ.

Add to this our team of Technical Sales Representatives (some with over 25 years experience in excavation safety) and our technical solutions we provide robust safety and efficiency for any project.

### Shoring

Our aim is to assist our customers in creating safe working environment for their employees, we offer a wide range of shoring products including Trench Boxes, Trench Sheets, Larssen Piles, Hydraulic Bracing as well as accompanying safety ranges to ensure safe access and egress to excavations. In support of the hire and sale of shoring equipment, we provide a temporary works design service carried out by highly qualified independent engineers to ensure risk managed, value driven solutions for our customers. Our mission is to be a trusted supplier of excavation safety solutions and exceptional customer service.

### Speak To Our Experts



**0800 779 7113**

**[groundworks.enquiries@altradgeneration.com](mailto:groundworks.enquiries@altradgeneration.com)**



# Groundworks Services

## Temporary Works Design - Experts in Excavation Safety Design

All of our equipment comes with optional temporary works and engineering design support, including full construction grade temporary works designs, installation drawings, industry recognised checks and full engineering certification.

Altrad Generation's dedicated design department offer tailored excavation solutions utilising our wide range of specialist excavation support equipment. Our industry leading turnaround times ensure that our customers receive their completed designs exactly when they're needed.

Our qualified team of civil, structural and mechanical engineers work to all industry legislation, standards and guidance, including:

- The Health and Safety at Work Act 1974
- BS 8002:2015
- Working at Height Regulations 2005 + AMD 2007
- BS 5975:2008 Code of practice for temporary works procedures and the permissible stress design of falsework
- BS 6031:2009 Code of Practice for Earthworks
- Construction (Design and Management) Regulations 2015
- Piling Handbook (9th Ed) Published by Arcelor Mittal
- The Lifting Operations and Lifting Regulations (LOLER) 1998
- CIRIA Report 104: Design of Retaining Walls Embedded in Stiff Clays
- CIRIA Special Publication 95: The Design and Construction of Sheet-Piled Cofferdams
- CPA STIG Safety in Shoring Manual 2006

Our design service is completely complimentary in most cases, and supports the full range of excavation support equipment and related safety systems.

The service involves our technical sales representatives attending site and working directly with installation contractors to ensure our temporary works design is as safe and efficient as possible. This process removes the need for numerous phone calls between site managers, buyers and ourselves, easing pressure on your busy team.

It also allows us to create a fully tailored solution quotation for each and every project we're involved with.

Contact our excavation safety experts to discuss your project requirements:

**0800 779 7113**  
**[groundworks.enquiries@altradgeneration.com](mailto:groundworks.enquiries@altradgeneration.com)**

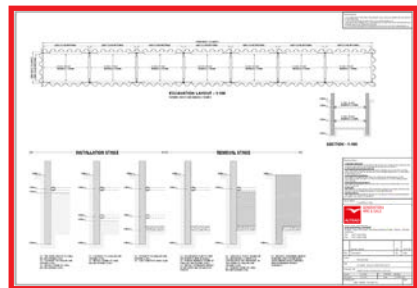
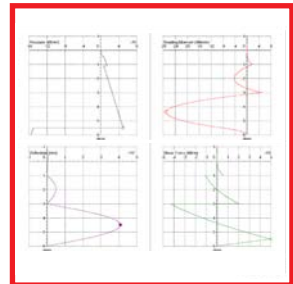



# Design Request Form - Speak to our Experts

LW.03.19

## DESIGN REQUEST FORM

Generation UK LTD



Branch:

**To be completed by Generation representative**

Design Request No:	<input type="text"/>	Fax:	<input type="text"/>
Generation Rep:	<input type="text"/>	Email:	<input type="text"/>
Tel:	<input type="text"/>		

ALL FIELDS MUST BE COMPLETED

### General Information

Date Requested:	<input type="text"/>	DD/MM/YYYY	Site Contact
Date Design Required:	<input type="text"/>	DD/MM/YYYY	Name: <input type="text"/>
Start Date (Approx):	<input type="text"/>	DD/MM/YYYY	Tel: <input type="text"/>
Customer:	<input type="text"/>		Email: <input type="text"/>
Main Contractor:	<input type="text"/>		Temporary Works Co-Ordinator
Site Location:	<input type="text"/>		Name: <input type="text"/>
Site Postcode:	<input type="text"/>		Tel: <input type="text"/>
Scheme Title:	<input type="text"/>		Email: <input type="text"/>
Live Scheme	<input type="checkbox"/>		
Tender Scheme	<input type="checkbox"/>		

### Excavation

Purpose of Excavation: <small>(eg. Tank, Pipe Retaining Wall)</small>	<input type="text"/>	Design Requirement:	Temporary <input type="checkbox"/>
Type of Support Required:			Permanent <input type="checkbox"/>
Cofferdam	<input type="checkbox"/>	Duration of Excavation:	Less than 12 Weeks <input type="checkbox"/>
Trench	<input type="checkbox"/>		More than 12 Weeks <input type="checkbox"/>
Canilever	<input type="checkbox"/>	Design Package Required:	Category A <input type="checkbox"/>
Stepped	<input type="checkbox"/>		Working DWG, Quote, CAD, Installation stages
Excavation Dimensions: <small>(all dimensions in m)</small>			Category B <input type="checkbox"/>
			Prelim, Quote, CAD DWG
			Category C <input type="checkbox"/>
			Prelim, quote

	Length	Width	Depth	Other
Sheet to Sheet	<input type="text"/>	<input type="text"/>	<input type="text"/>	<input type="text"/>
Clear Internal	<input type="text"/>	<input type="text"/>	<input type="text"/>	<input type="text"/>



Page 1 of 4



## Trench Boxes

Altrad Generation Trench Boxes are simple to assemble, two-sided excavation support systems designed to be installed by an excavator utilising the 'dig and push' or 'excavate and lower' techniques. Trench boxes are often used where rapid installation of utility pipelines and trench runs are required. Trench Boxes provide a safe working environment for those on site by safely withstanding the surrounding soil pressure. Trench Boxes can be used in conjunction with four-sided Manhole Boxes to provide complete protection for personnel. Drag Boxes offer a speedy alternative to a Trench Box when laying long pipe runs. If the Permissible SWL is exceeded, **ALWAYS** enquire about our design service. Manhole Braces and Alloy Waller's can be used as alternatives.



### Backhoe Trench Box

	Base Unit	Top Unit
Length (mm)	3000	3000
Height (mm)	2000	960
Min Width External (mm)	690	690
Max Width External (mm)	2690	2690
Min Width Internal (mm)	570	570
Max Width Internal (mm)	2570	2570
Thickness (mm)	60	60
Max Clearance Between Struts (mm)	2690	2690
Max Clearance Under Lower Strut (mm)	980	-
Permissible SWL (kN/m <sup>2</sup> )	19.40	19.40
Weight (kg)	822	441
Max Depth (mm)	2960	-

The Backhoe Trench Box is a lightweight Trench Box designed for inner city shoring jobs. Used to support sides of excavations, generally used for the laying of small diameter utility pipes such as gas, water, telecoms or power cables. Designed for use with smaller machines such as 180' excavators and rubber tyred excavators. Lightweight alternative to Standard & Mini Trench Boxes when lifting capacity is an issue on site. Effective down to 3.00m, provided ground pressure does not exceed the Permissible SWL of 19.40 kN/m<sup>2</sup> for this box.

# Trench Boxes

## Backhoe Trench Box



The Backhoe Trench Box is a robust piece of equipment, which acts as a safety shield to provide a safe working area below ground level. For use when working on excavations and pipe laying operations. The Backhoe Trench Box can sustain working earth pressures of up to 20kN/m<sup>2</sup>, users should check that the excavation will not impose greater pressures than this.

Installation is easy through the 'Dig and Push' method. This ensures that the side walls of the excavation are supported, and minimises the likelihood of an accident. The panels are 3000mm long by 2000mm deep with a width range of 720mm to 1720mm which can be altered using telescopic struts these are secured in place using the 'Pin and Clip' system, which connects all components. Backhoe box tops can be used to obtain 3000mm in depth.

- Provides safe working area below ground
- SWL of 20kN/m<sup>2</sup>
- Easily Assembled
- Dig and Push method
- 3000m long x 2000m base panels
- Width range of 720mm to 1720mm
- Extension tops are 3000mm x 1000mm
- Maximum working depth 3000mm
- Pin and 'R' Clip method
- Base unit weight of 730kg
- 1200mm clearance below lower strut
- Additional Equipment available

	Struts	Internal (mm)
	Size 1	600 - 800
	Size 2	800-1000
	Size 3	1000-1200
	Size 4	1200-1400
	Size 5	1400-1600

Backhoe Trench Box	Base	Top
Panel Length (mm)	3000	3000
Panel Height (mm)	2000	1000
Panel Thickness (mm)	60	60
Overall External Trench Width (mm)	720 - 1720	720 - 1720
Weight (kg)	730	420
Distance Between Struts (mm)	2670	2670
Clearance Below Strut	1200	-
Standard Working Load	20kN/m <sup>2</sup>	20kN/m <sup>2</sup>



## Trench Boxes

### BV60 Trench Box

	Base Unit	Top Unit
Length (mm)	3000	3000
Height (mm)	2000	1000
Min Width External (mm)	820	820
Max Width External (mm)	3820	3820
Min Width Internal (mm)	700	700
Max Width Internal (mm)	3700	3700
Thickness (mm)	60	60
Max Clearance Between Struts (mm)	2600	2600
Max Clearance Under Lower Strut (mm)	950	-
Permissible SWL (kN/m <sup>2</sup> )	23.50	23.50
Weight (kg)	1154	638
Max Depth (mm)	4000	-

Two-sided mechanical excavation support BV60 Trench Boxes, ideal for the installation of utility pipes and services when ground movement is non-critical. This simple and easy to assemble system has adjustable struts that allow quick width adjustments in trench sizes up to 4m deep and 3.820m wide. Designed to be installed by an excavator using either the dig and push or excavate and lower in place technique, Bottom cutting edge for ease of installation, Top panels available to increase excavation depth & compatible with End panels.

# Trench Boxes

## Mini Trench Box



The Mini Trench Box can be used in trenches up to 4000mm deep with widths from 610mm to 3200mm, which can be altered using telescopic struts. Up to two extension boxes can be added on top of the mini Trench Box to achieve additional depth.

- Support Below Ground
- Quick & Easy To Install
- Extension Boxes Available To Increase Depth
- Used In Trenches Up To 4000mm Deep
- Dig & Push Method Used
- Pin & Clip System
- Additional Equipment Available

	Struts	Internal (mm)
	Size 0	600 - 800
	Size 1	800 - 1200
	Size 2	1200 - 1600
	Size 3	1600 - 2000
	Size 4	2000 - 2400

Mini Trench Box	Base	Top
Panel Length (mm)	3000	3000
Panel Height (mm)	2000	1000
Panel Thickness (mm)	60	60
Overall External Trench Width (mm)	610 - 3200	610 - 3200
Weight (kg)	1232	676
Distance Between Struts (mm)	2720	2720
Clearance Below Strut	1100	-
Standard Working Load	20kN/m <sup>2</sup>	20kN/m <sup>2</sup>



## Trench Boxes

### BV100 Trench Box

	Base Unit	Top Unit	Base Unit	Top Unit
Length (mm)	3500	3500	5000	5000
Height (mm)	2360	1300	2360	1570
Min Width External (mm)	900	900	1500	1500
Max Width External (mm)	3900	3900	4000	4000
Min Width Internal (mm)	700	700	1290	1290
Max Width Internal (mm)	3700	3700	3790	3790
Thickness (mm)	100	100	120	120
Max Clearance Between Struts (mm)	3114	3114	4610	4610
Max Clearance Under Lower Strut (mm)	1540	-	-	-
Permissible SWL (kN/m <sup>2</sup> )	39.70	39.70	34.30	34.30
Weight (kg)	2094	1368	3180	2170
Max Depth (mm)	6260	-	-	-

With its easy 'pin and clip' adjustment the BV100 Trench Box is the most advanced and effective box currently being used within the industry. Our BV100 Trench Box being one of the strongest on the market is able to withstand ground pressure of 39.70 kN/m<sup>2</sup> and is robust enough to withstand the rigours of everyday site work. Effective down to 6.50m, provided ground pressure does not exceed the Permissible SWL of 39.70 kN/m<sup>2</sup> of this box.

## Trench Boxes

### Magnum Trench Box

	Base Unit	Top Unit
Length (mm)	3400	3400
Height (mm)	4000	1970
Min Width External (mm)	960	960
Max Width External (mm)	4150	4150
Min Width Internal (mm)	760	960
Max Width Internal (mm)	3950	3950
Thickness (mm)	100	100
Max Clearance Between Struts (mm)	2950	2950
Max Clearance Under Lower Strut (mm)	2460	-
Permissible SWL (kN/m <sup>2</sup> )	36.41	36.41
Weight (kg)	3136	2450
Max Depth (mm)	6640	-

The Magnum Trench Box is the largest in the range of Altrad Generation trench boxes. It is designed for deep pipe laying activities. The design is similar to Std & BV100 Trench Boxes but it can achieve greater clearance under struts to allow larger diameter pipes to be installed. It provides clearance of 2460mm under strut through a panel height of 4000mm. Effective down to 6.60m, provided ground pressure does not exceed the Permissible SWL of 36.41 kN/m<sup>2</sup> of this box.



# Trench Boxes

## Standard Trench Box



The Standard Trench Box is used to provide a safe working area below ground and ensure that the side walls of an excavation are continually supported. Standard Trench Boxes can be used in conjunction with other boxes, including Manhole Boxes. They are quick and easy to install.

The Standard Trench Box can be used in trenches up to 5600mm deep with widths from 690mm to 4500mm. Up to two extension boxes can be added on top of the standard Trench Box to achieve additional depth if needed.

- Two-sided Support
- Used In Conjunction With Manhole Boxes
- Additional Top Boxes Available
- Quick & Easy To Install
- Dig & Push Method Used
- Additional Equipment Available

	Struts	Internal (mm)
	Size 0	600 - 800
	Size 1	800 - 1200
	Size 2	1200 - 1600
	Size 3	1600 - 2000
	Size 4	2000 - 2400

Standard Trench Box	Base	Top
Panel Length (mm)	3500	3500
Panel Height (mm)	2600	1500
Panel Thickness (mm)	100	100
Overall External Trench Width (mm)	690 - 4500	690 - 4500
Weight (kg)	2100	1130
Distance Between Struts (mm)	3210	3210
Clearance Below Strut	1500	-
Standard Working Load	40kN/m <sup>2</sup>	40kN/m <sup>2</sup>



# Trench Boxes

## Super Trench Box



The Super Trench Box is used to provide a safe working area below ground and ensure that the side walls of an excavation are continually supported. Standard Trench Boxes can be used in conjunction with other boxes, including manhole boxes. They are quick and easy to install.

The Standard Trench Box can be used in trenches up to 6.1m deep with widths from 700mm to 3300mm. Up to two extension boxes can be added on top of the Standard Trench Box to achieve additional depth if needed.

- Two-sided support
- Used in conjunction with Manhole Boxes
- Additional top boxes available
- Quick and easy to install
- Dig and Push method used
- Edge Safe systems available
- Ladder Access systems available
- Additional Equipment Available

Struts	Internal (mm)	External (mm)
Fixed 700	700	900
Fixed 800	800	1000
Fixed 1000	1000	1200
Fixed 1200	1200	1400
Fixed 1500	1500	1700
A1	1000 - 1300	1200 - 1500
A	1200 - 1500	1400 - 1700
B	1500 - 2100	1700 - 2300
C	2100 - 3300	2300 - 3500

Super Trench Box	Base	Top
Panel Length (mm)	5.1	5.1
Panel Height (mm)	2.5	1.8
Panel Thickness (mm)	100	100
Minimum trench width(mm)	700	700
Maximum trench width(mm)	3.3	3.3
Maximum clearance between struts	4.62	4.62
Maximum clearance below strut	1.5	N/A
Weight(kg)	3800kg*	2280kg*
Super working load	40kN/m <sup>2</sup>	40kN/m <sup>2</sup>

\*Varies with strut width

## Drag Boxes

Drag Boxes are a speedy alternative to Trench Boxes, where speed of production is paramount. The Drag Box is used in stable, self supporting soil conditions, and is lowered into a pre-dug trench. Then, with the aid of an excavator, it is dragged along via the front strut as pipe production moves along the trench. In order to enable this, a Drag Box has a cutting edge on the front of the box rather than at the bottom. Drag Boxes also tend to be used on green or brown field sites, where there are no services or obstructions. Drag Boxes should only be used as a shield not as a support.



### Drag Box 3m

	Base Unit	Top Unit
Length (mm)	3000	3000
Height (mm)	2000	1000
Min Width External (mm)	760	760
Max Width External (mm)	2660	2660
Min Width Internal (mm)	600	600
Max Width Internal (mm)	2500	2500
Thickness (mm)	80	80
Max Clearance Between Struts (mm)	2200	2200
Max Clearance Under Lower Strut (mm)	1000	-
Permissible SWL (kN/m <sup>2</sup> )	-	-
Weight (kg)	2000	1000
Max Depth (mm)	3000	-

### Drag Box 4m

	Base Unit	Top Unit
Length (mm)	4000	4000
Height (mm)	2420	1820
Min Width External (mm)	760	760
Max Width External (mm)	2660	2660
Min Width Internal (mm)	600	600
Max Width Internal (mm)	2500	2500
Thickness (mm)	100	100
Max Clearance Between Struts (mm)	3120	3120
Max Clearance Under Lower Strut (mm)	1380	-
Permissible SWL (kN/m <sup>2</sup> )	-	-
Weight (kg)	2510	1970
Max Depth (mm)	4240	-



## Drag Boxes

### Drag Box 5m

	Base Unit	Top Unit
Length (mm)	5000	5000
Height (mm)	2500	1800
Min Width External (mm)	800	800
Max Width External (mm)	2700	2700
Min Width Internal (mm)	600	600
Max Width Internal (mm)	2500	2500
Thickness (mm)	100	100
Max Clearance Between Struts (mm)	4200	4200
Max Clearance Under Lower Strut (mm)	1470	-
Permissible SWL (kN/m <sup>2</sup> )	-	-
Weight (kg)	3050	2100
Max Depth (mm)	4300	-

### Drag Box 7m

	Base Unit	Top Unit
Length (mm)	7000	7000
Height (mm)	2420	1820
Min Width External (mm)	800	800
Max Width External (mm)	2700	2700
Min Width Internal (mm)	600	600
Max Width Internal (mm)	2500	2500
Thickness (mm)	100	100
Max Clearance Between Struts (mm)	6120	6120
Max Clearance Under Lower Strut (mm)	1380	1380
Permissible SWL (kN/m <sup>2</sup> )	-	-
Weight (kg)	4620	3570
Max Depth (mm)	4240	-

# Drag Boxes

## Drag Box



The Drag Box acts as a shield to protect users in self-supporting soil. It is designed to withstand up to 25kN/m<sup>2</sup>. Installation requires the 'Excavate and Drag' technique, the box is placed in a pre-dug trench and moved after each instalment of pipe.

- Lifting points for safe slinging
- For use in self-supporting soil
- Standard Drag Box 4 Struts
- Edge Safe Systems Available
- Ladder Access System Available
- Can be used in conjunction with Manhole Boxes

Struts	Internal (mm)	External (mm)
Fixed 700	700	900
Fixed 800	800	1000
Fixed 1000	1000	1200
Fixed 1200	1200	1400
Fixed 1500	1500	1700
A1	1000 - 1300	1200 - 1500
A	1200 - 1500	1400 - 1700
B	1500 - 2100	1700 - 2300
C	2100 - 3300	2300 - 3500

Standard Drag Box	5.0m x 1.8m	5.0 x 2.5m	7.0m x 2.0m
Panel Length (mm)	5000	5000	7000
Panel Height (mm)	1800	2500	2000
Panel Thickness (mm)	100	100	100
Minimum External Trench Width (mm)	700	700	700
Maximum Internal trench width (mm)	3300	3300	3300
Clearance Between Struts (mm)	4520	4520	6580
Max Clearance Below Bottom Strut	1072	1500	1500
Maximum Weight (kg)	2370	3020	4550
Standard Working Load	25kN/m <sup>2</sup>	25kN/m <sup>2</sup>	25kN/m <sup>2</sup>



# Drag Boxes

## Maxi Drag Box



The Maxi Drag Box is ideal for use with long pipe runs, the size increases productivity allowing for a faster installation time. The Maxi Drag Box can be installed using the 'Excavate and Drag' technique. The box is placed in a pre-dug trench and pulled along the trench as each section of pipe laying is completed.

- For use in self-supporting soil
- Lightweight
- From 2400kg in weight
- Edge protection systems available
- Ladder access systems available
- Can be used in conjunction with Manhole Boxes

Struts	Size (mm)	Internal (mm)
Size A	508	550 - 750
Size B	838	800 - 1150
Size C	1190	1150 - 1500
Size D	1540	1500 - 1850
Size E	1890	1850 - 2000

Maxi Drag Box	4.0m x 2.0m	4.0m x 1.0m	5.0m x 2.0m	5.0 x 1.0m
Panel Length (mm)	4000	4000	5000	5000
Panel Height (mm)	2000	1000	2000	1000
Panel Thickness (mm)	100	100	100	100
Minimum External Trench Width (mm)	750	750	750	750
Maximum Internal Trench width (mm)	2000	2000	2000	2000
Maximum Clearance Between Struts (mm)	3870	3870	4830	4830
Max Clearance Below Bottom Strut (mm)	1200	-	1200	-
Weight (kg)	1960	1060	2400	1290
Standard Working Load	20kN/m <sup>2</sup>	20kN/m <sup>2</sup>	20kN/m <sup>2</sup>	20kN/m <sup>2</sup>



## Backhoe Manhole Boxes

Backhoe Manhole Boxes are lightweight boxes, complete with integral end return panels providing additional support making them ideal for installing pre-cast manhole rings. Suitable for excavation depths up to 2.96m Simple pinned strut arrangement. A range of strut lengths is available for non-square configurations. End closure panels available to support the open ends of the box. Trench Guard Edge Protection Panels available & Four way handling point to aid safe assembly.

### 2m Backhoe Manhole Box

	Base Unit	Top Unit
Length (mm)	2000	2000
Height (mm)	2000	960
Min Width External (mm)	1690	1690
Max Width External (mm)	3690	3690
Min Width Internal (mm)	1570	1570
Max Width Internal (mm)	3570	3570
Thickness (mm)	60	60
Max Clearance Between Struts (mm)	1600	1600
Max Clearance Under Lower Strut (mm)	980	-
Permissible SWL (kN/m <sup>2</sup> )	38.00	38.00
Weight (kg)	1186	711
Max Depth (mm)	2960	-

### 2.5m Backhoe Manhole Box

	Base Unit	Top Unit
Length (mm)	2500	2500
Height (mm)	2000	960
Min Width External (mm)	1690	1690
Max Width External (mm)	3690	3690
Min Width Internal (mm)	1570	1570
Max Width Internal (mm)	3570	3570
Thickness (mm)	60	60
Max Clearance Between Struts (mm)	2100	2100
Max Clearance Under Lower Strut (mm)	980	-
Permissible SWL (kN/m <sup>2</sup> )	30.40	30.40
Weight (kg)	1326	769
Max Depth (mm)	2960	-



## Backhoe Manhole Boxes

### 3m Backhoe Manhole Box

	Base Unit	Top Unit
Length (mm)	3000	3000
Height (mm)	2000	1000
Min Width External (mm)	1690	1690
Max Width External (mm)	3690	3690
Min Width Internal (mm)	1570	1570
Max Width Internal (mm)	3570	3570
Thickness (mm)	60	60
Max Clearance Between Struts (mm)	2630	2630
Max Clearance Under Lower Strut (mm)	980	-
Permissible SWL (kN/m <sup>2</sup> )	32	32
Weight (kg)	1190	680
Max Depth (mm)	3000	-



# Backhoe Manhole Boxes

## Backhoe Manhole Box



The Backhoe Manhole Box is a four-sided excavation box which provides a safe working area below ground. The Backhoe Manhole Box can sustain earth pressures of 20kN/m<sup>2</sup>. Users should check that the excavation will impose no greater pressures than this.

Installation is easy through the 'Dig and Push' method. This ensures that the side walls of the excavation are supported and minimises the likelihood of an accident. Three panel lengths are available 2000mm, 2500mm or 3000mm. A top box can be used to increase depth to a maximum of 3000mm.

- Provides safe working area below ground
- Easily Assembled
- Dig and Push method
- Pin and Clip System
- SWL 20kN/m<sup>2</sup>
- Base unit weight 808kg and 975kg
- 2000mm, 2500mm or 3000mm panel lengths
- 1200mm clearance between lower strut
- Panel Thickness 60mm
- Closing panels available
- Additional equipment available

Backhoe Manhole Box	2m		2.5m		3m	
	Base	Top	Base	Top	Base	Top
Panel Length (mm)	2000	2000	2500	2500	3000	3000
Panel Height (mm)	-	-	-	1000	2000	1000
Panel Thickness (mm)	60	60	60	60	60	60
Weight (kg)	808	507	875	460	975	508
Distance Between Struts (mm)	1840	1840	2340	2340	2840	2840
Clearance Below Strut (mm)	1200	-	1200	-	1200	-
To Suit Ring Size (mm)	1050/1200		1050 / 1200 / 1350		1350 / 1500 / 1800	
Standard Working Load	20kN/m <sup>2</sup>	20kN/m <sup>2</sup>	20kN/m <sup>2</sup>	20kN/m <sup>2</sup>	20kN/m <sup>2</sup>	20kN/m <sup>2</sup>



## BV100 Manhole Boxes

A four-sided mechanical excavation support Manhole Box, ideal for installing pre-cast concrete manholes and small chambers or tanks where ground movement is non-critical. Can be used to form part of a continuous trench system in excavations up to 5.3m deep and 4.7m wide.

- Designed to be installed by excavator using either the dig and push or excavate and place technique
- Bottom cutting edge for ease of installation
- Top panels available to increase excavation depth



If you are unsure about the depth or SWL, we recommend that you speak to us about our design service. Call all our excavation safety experts on 0800 779 7113 or email [groundworks.enquiries@altradgeneration.com](mailto:groundworks.enquiries@altradgeneration.com) to discuss your project requirements.

Manhole Braces are a good alternative if SWL are expected to be exceeded and/or if cross services are an issue on-site.

**ALWAYS enquire about design service if unsure.**

Manhole Boxes are similar to Trench Boxes in their basic function, however they incorporate integral end return panels thus providing additional ground support, making them ideal for installing pre-cast manhole rings in trench runs as an alternative to using sheets and frames. There are six sizes of Manhole Box available to cater for common sizes of pre-cast manhole rings. Each box can be assembled and installed quickly and without the need for an operative to enter the unsupported excavation. Manhole Boxes can be used in most ground conditions to support trenches with depths of up to 5.3m by utilising the base module with two box tops and a variety of different strut types. Trench Guard Edge Protection system is available for this product. Four-way handling points to aid safe assembly.





## BV100 Manhole Boxes

### BV100 Manhole Box 2.5m

	Base Unit	Top Unit
Length (mm)	2500	2500
Height (mm)	2360	1470
Min Width External (mm)	1900	1900
Max Width External (mm)	4900	4900
Min Width Internal (mm)	1700	1700
Max Width Internal (mm)	4700	4700
Thickness (mm)	100	100
Max Clearance Between Struts (mm)	2080	2080
Max Clearance Under Lower Strut (mm)	1540	-
Permissible SWL (kN/m <sup>2</sup> )	55-70	55-70
Weight (kg)	2026	1449
Max Depth (mm)	5300	-

### BV100 Manhole Box 3.0m

Length (mm)	3000	3000
Height (mm)	2360	1470
Min Width External (mm)	1900	1900
Max Width External (mm)	4900	4900
Min Width Internal (mm)	1700	1700
Max Width Internal (mm)	4700	4700
Thickness (mm)	100	100
Max Clearance Between Struts (mm)	2580	2580
Max Clearance Under Lower Strut (mm)	1540	-
Permissible SWL (kN/m <sup>2</sup> )	46-40	46-40
Weight (kg)	2226	1589
Max Depth (mm)	5300	-

### BV100 Manhole Box 3.5m

Length (mm)	3500	3500
Height (mm)	2360	1470
Min Width External (mm)	1900	1900
Max Width External (mm)	4900	4900
Min Width Internal (mm)	1700	1700
Max Width Internal (mm)	4700	4700
Thickness (mm)	100	100
Max Clearance Between Struts (mm)	3050	3080
Max Clearance Under Lower Strut (mm)	1540	-
Permissible SWL (kN/m <sup>2</sup> )	39-70	39-70
Weight (kg)	2426	1729
Max Depth (mm)	5300	-



## BV100 Manhole Boxes

### BV100 Manhole Box 4.0m

	Base Unit	Top Unit
Length (mm)	4000	4000
Height (mm)	2360	1470
Min Width External (mm)	1900	1900
Max Width External (mm)	4900	4900
Min Width Internal (mm)	1700	1700
Max Width Internal (mm)	4700	4700
Thickness (mm)	100	100
Max Clearance Between Struts (mm)	4080	4080
Max Clearance Under Lower Strut (mm)	1540	-
Permissible SWL (kN/m <sup>2</sup> )	31-85	31-85
Weight (kg)	2616	1869
Max Depth (mm)	5300	-

### BV100 Manhole Box 4.5m

Length (mm)	4500	4500
Height (mm)	2360	1470
Min Width External (mm)	1900	1900
Max Width External (mm)	4900	4900
Min Width Internal (mm)	1700	1700
Max Width Internal (mm)	4700	4700
Thickness (mm)	100	100
Max Clearance Between Struts (mm)	3580	3580
Max Clearance Under Lower Strut (mm)	1540	-
Permissible SWL (kN/m <sup>2</sup> )	30-60	30-60
Weight (kg)	3326	2329
Max Depth (mm)	5300	-

### BV100 Manhole Box 5.0m

Length (mm)	5000	5000
Height (mm)	2360	1470
Min Width External (mm)	1900	1900
Max Width External (mm)	4900	4900
Min Width Internal (mm)	1700	1700
Max Width Internal (mm)	4700	4700
Thickness (mm)	100	100
Max Clearance Between Struts (mm)	4580	4580
Max Clearance Under Lower Strut (mm)	1540	-
Permissible SWL (kN/m <sup>2</sup> )	24-50	24-50
Weight (kg)	3576	2509
Max Depth (mm)	5300	-

# Manhole Boxes

## Manhole Box

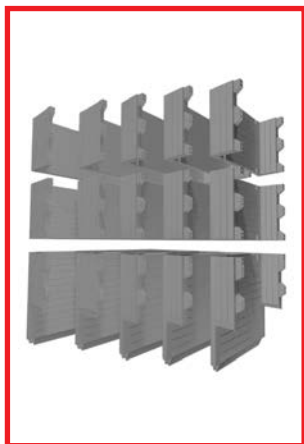

The Manhole Box is a four-sided excavation protection system, which is used whilst installing pre-cast manholes, chambers or tanks. The Manhole Box can be used in conjunction with trench boxes.

The Manhole Box is quick and easy to install and can be used in trenches up to 5500mm deep. Four different sized panels are available to suit a wide range of needs, these sizes also suit all pre-cast manhole rings. Two additional top boxes can be used with the Manhole Base Box to increase the depth to 5500mm.

- Four Sided
- Dig & Push Method Used
- Additional Extension Boxes
- Used In Excavations Up To 5500m In Depth
- Four Different Sizes Available
- Closing Panels Available
- Edge Safe Systems Available
- Ladder Access System Available

Manhole Box	2.5mm		3.0m		3.5mm		4.0m		4.7m	
	Base	Top	Base	Top	Base	Top	Base	Top	Base	Top
Panel Length (mm)	2500	2500	3000	3000	3500	3500	4000	4000	4700	4700
Panel Height (mm)	2500	1500	2500	1500	2500	1500	2500	1500	2500	1500
Panel Thickness (mm)	100	100	100	100	100	100	100	100	100	100
Weight (kg)	2402	1374	2608	1670	2800	1800	3570	2370	4850	2910
Distance Between Struts (mm)	2220	2220	2720	2720	3220	3220	3780	3780	4490	4490
Strut Height Clearance (mm)	1500	-	1500	-	1500	-	1500	-	1500	-
To Suit Ring Size (mm)	1050/1200/1350		1350/1500/1800		1800/2100		2100/2400/2700		3000	
Standard Working Load	40kN/m <sup>2</sup>		40kN/m <sup>2</sup>		40kN/m <sup>2</sup>		40kN/m <sup>2</sup>		35kN/m <sup>2</sup>	



## Trench Box Safety Ancillaries

### End Panels



End panels are used in conjunction with Altrad Generation Trench, Manhole and Drag Boxes to safely seal off the open ends of an excavation and provide a completely enclosed working environment.

Code	Product/Dimensions W X H	SWL (Kn/M <sup>2</sup> )	Weight
<b>084793</b>	2500mm x 2500mm	36.4	650kg
<b>084794</b>	1800mm x 1200mm	36.4	179kg
<b>084795</b>	2400mm x 1200mm	36.4	242kg
<b>084796</b>	2400mm x 1800mm	36.4	329kg
<b>084797</b>	3000mm x 2000mm	36.4	452kg
<b>084802</b>	End Panel Connector	-	-
<b>084803</b>	End Panel Connector Pin	-	-

### Trench Guard Edge Protection



Trench Guard Edge Protection has been designed to protect work personnel from open excavations and falling debris. Trenchguard conforms to the latest temporary edge protection. Legislation BS EN 13374:2013 and is certified for Fall Protection Worldwide. Trenchguard has a built-in toe board to prevent debris from falling onto operatives working below. Fits all types of excavation equipment. Lightweight for ease of use by site operatives and quick installation when used in conjunction with post and clamps.

Code	Product/Dimensions W X H	SWL (Kn/M <sup>2</sup> )	Weight
<b>084909</b>	Trench Guard Panel	2245mm x 1150mm	15.00kg
<b>084910</b>	Trench Guard Panel	2700mm x 1150mm	18.00kg
<b>084911</b>	Trench Guard Panel	1800mm x 1150mm	12.00kg
<b>084912</b>	Corner Panel	775mm x 775mm	10.00kg
<b>084913</b>	Telescopic Box Clamp	-	5.00kg
<b>084914</b>	Telescopic Sheet Clamp	-	4.00kg

# Trench Box Safety Ancillaries

## Edge Protection



The Edge Protection System protects users below ground as well as minimizing the risk of falling into an excavation from ground level. Our edge protection also conforms to BSEN 133374 Class A Temporary Edge Protection System Standards. They can be clamped onto panels quickly and easily.

- Quick and Easy Installation
- Promotes Site Safety
- Lightweight
- Clamps onto panels and sheets
- Fall prevention system
- Complies to work at height regulations
- Easy to store on site
- Sizes 2.5m, 3m and 3.5m available
- Conforms to BSEN13374 Class A Temporary Edge Protection Systems

Guardrails	0.5m	2.0m	2.5m	3.0m	3.5m
Rail Length (mm)	500	2000	2500	3000	3500
Rail Height (mm)	1200	1200	1200	1200	1200

## Ladder Safe



Manufactured from mild steel with a powder coated finish. Specially designed for use on all types of box and sheeted excavations. Cantilevered platform enables safe side-entry onto ladder. Standard pole ladder fits directly onto the unit and is locked in place with two ladder clamps. Adjustable clamps fit directly onto a Trench Box or sheets (two sheet clamps and two box clamps supplied with platform). Adjustable front legs for ease of levelling. Collapsible sides and gate for ease of storage.

Code	Product/Dimensions W X H	SWL (kN/m <sup>2</sup> )	Weight
<b>084917</b>	Mini Ladder Safe Platform	72	650.00kg
<b>084919</b>	Collapsible Ladder Safe Platform	98	179.00kg



## Trench Box Safety Ancillaries

### Davit Arm



Altrad Generation Davit Arms' unique four piece construction allows single operative installation and ease of use on site. Allowing its manual rescue winch to easily lift upto 140kg from all types of box and sheeted excavations.

Code	Product/Dimensions W X H	SWL (kN/m <sup>2</sup> )	Weight
089408	Davit Arm	140	75.00kg

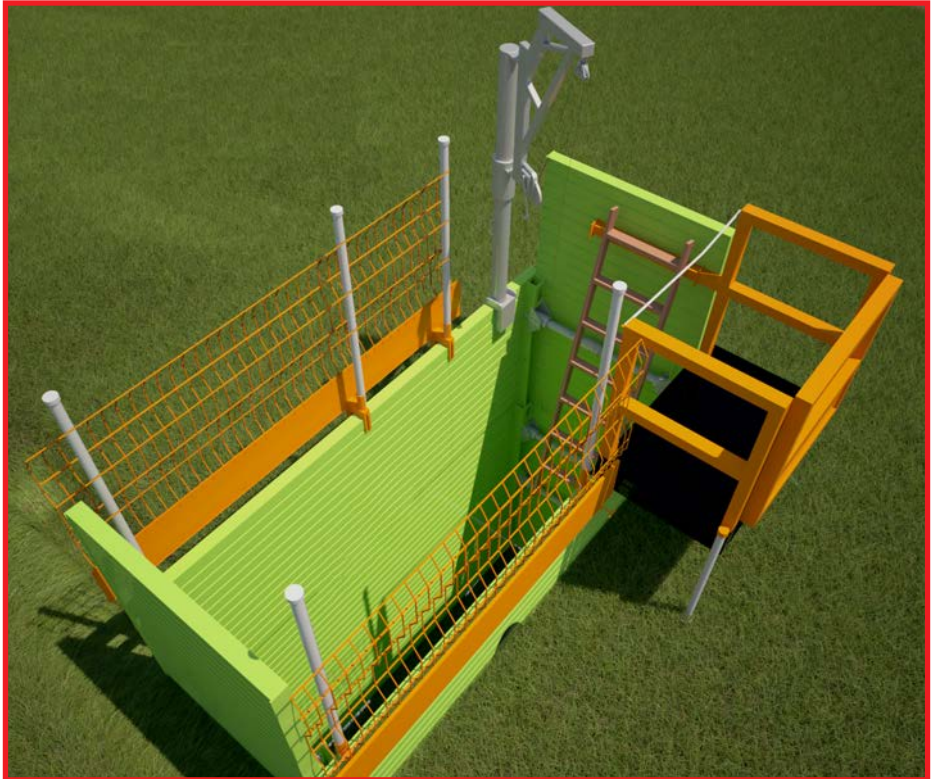



## Alloy Waler Rails



Alloy Waler Rails are used as an alternative to Trench Boxes where cross services are an issue. They are mainly used in city center and highway excavations where ground movement must be kept to a minimum. They offer a two-sided hydraulic support system used in conjunction with Altrad Generation Trench Sheets to allow a clear working area for the inspection/laying of utilities.

Code	Waler Cylinder	Min Length	Max Length	Swl (Kn)	Weight
086090	Type A	505mm	805mm	80	12.00kg
086091	Type B	705mm	1205mm	80	15.00kg
086092	Type C	1105mm	1605mm	80	22.00kg
086093	Type D	1505mm	2005mm	80	28.00kg
086101	1m Waler Cylinder Extensions to achieve 3m width			80	18.00kg

Code	Rail Size	Width	Swl (Kn/M)	Cylinders Required	Weight
086020	2000mm	100mm	22.91	2	22.00kg
086025	2500mm	100mm	22.91	2	27.50kg
086030	3000mm	100mm	22.91	2	33.00kg
086040	4000mm	100mm	22.91	2	44.00kg
086050	5000mm	100mm	22.91	3	55.00kg

Code	Waler Cylinder	Min Length	Max Length	Swl (Kn)	Weight
086090	Type A	530mm	820mm	80	10.00kg
086091	Type B	780mm	1310mm	80	16.00kg
086092	Type C	1260mm	2010mm	80	23.00kg
086101	1m Waler Cylinder Extensions to achieve 2.75m width			80	18.00kg

Code	Rail Size	Width	SWL (kN/m)	Cylinders Required	Weight
086120	2000mm	180mm	58	2	21.00kg
086125	2500mm	180mm	24	2	26.00kg
086130	3000mm	180mm	16	2	31.00kg
086140	4000mm	180mm	8.2	2	41.00kg
086150	5000mm	180mm	4.9	3	52.00kg



## Alloy Waler Rails

### Waler End Bearers

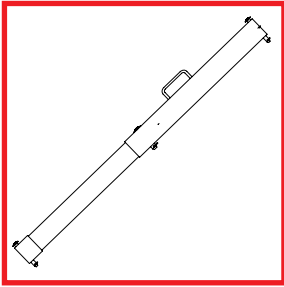

Our Aluminium Waler End Bearer system has been developed to be used with a wide range of Aluminium Waler Rails to provide lightweight support to non-battered ends of trenches. To be used in conjunction with Trench Sheets/existing Waler systems, this product offers a safe and efficient replacement to less suitable methods, such as timber or road plates, by retaining backfill, preventing accidental dislodgement of loose material and also a barrier to prevent unauthorised access to the excavation

Code	Min Length	Max Length	Weight
<b>086102</b>	530mm	820mm	13.50kg
<b>086103</b>	780mm	1310mm	20.00kg
<b>086104</b>	1260mm	2010mm	30.00kg

## Standard Hydraulic Manhole Brace



Hydraulic Manhole Braces are suitable for both square and rectangular excavations from 1.6m up to 9.4m.

The Double Acting Manhole Brace system incorporates a hydraulic system of adjustment which is designed to extend or retract the frames under conditions of no or low loading: e.g. as when first installed or as they become redundant after backfilling the excavation. Once they are sustaining significant ground loads, hydraulic extension or retraction of the frames is inadvisable this allows a safe working environment for manhole inspection work or new build projects. Hydraulic Manhole Brace is used with an installation kit when the soil conditions do not allow for a Manhole Box to be used, or, if cross services are involved in the scheme.

Code	Leg	External Min	External Max	Width Of Beam	Weight
<b>086020</b>	Type A	1600mm	2200mm	140mm	125kg
<b>086025</b>	Type B	2100mm	3000mm	140mm	150kg
<b>086030</b>	Type C	2700mm	4200mm	150mm	208kg
<b>086040</b>	Type D	3700mm	6000mm	180mm	316kg
<b>086050</b>	Type E	6347mm	9447mm	250mm	1300kg

Leg Type	Clear Internal Dimension (X)		Dimension Over Frame (Y)		Frame Weight
	Min	Max	Min	Max	
<b>A</b>	1320mm	1920mm	1600mm	2200mm	500kg
<b>B</b>	1820mm	2720mm	2100mm	3000mm	380kg
<b>C</b>	2420mm	3920mm	2700mm	4200mm	1004kg
<b>D</b>	3340mm	5720mm	3700mm	6000mm	1720kg
<b>E</b>	5847mm	8947mm	6347mm	9447mm	5200kg

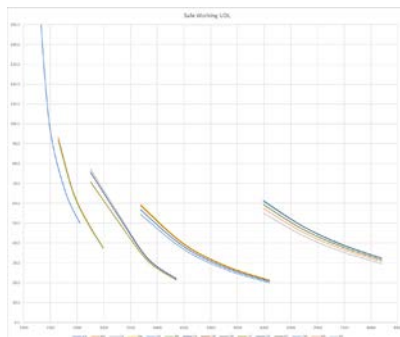
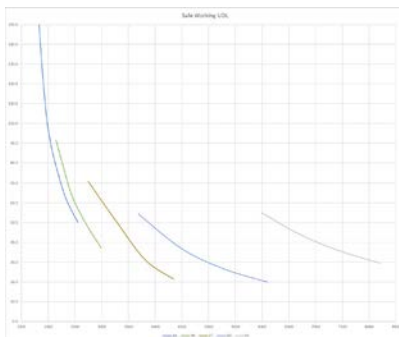



## Mammoth Plus

Mammoth Plus is the new and improved version of the market leading Mammoth Brace from Altrad Generation. The re-engineered and strengthened joint design means Mammoth Plus now offers significantly higher capacity, now 30% stronger, greatly improving the overall spans and allowing for larger excavations to be easily achieved. New hydraulic modules ensure outstanding flexibility and modularity with the Mammoth Plus system, allowing for a wider range of uses in the groundworks industry. These new improvements to the original Mammoth create an improved user experience, improve ease of installation and extend the application range significantly, certifying the new Mammoth Plus as a market leader.



Excavation supports using Mammoth Plus should be designed in accordance with the latest industry legislation, standards and guidance including:

- The Health and Safety at Work ACT 1974
- BS 5975:2019 Code of practice for temporary works procedures and the permissible stress design of falsework
- BS 6031:2009 Code of Practice for Earthworks
- Construction (Design and Management) Regulations 2015
- Piling Handbook (9 th Ed) by Arcelor Mittal
- Ciria Reports 104, 510, 760 and Special Publication 95

Due to its weight and size, consideration should be given to the lifting and moving of assembled components along with support chain or support bracket locations.

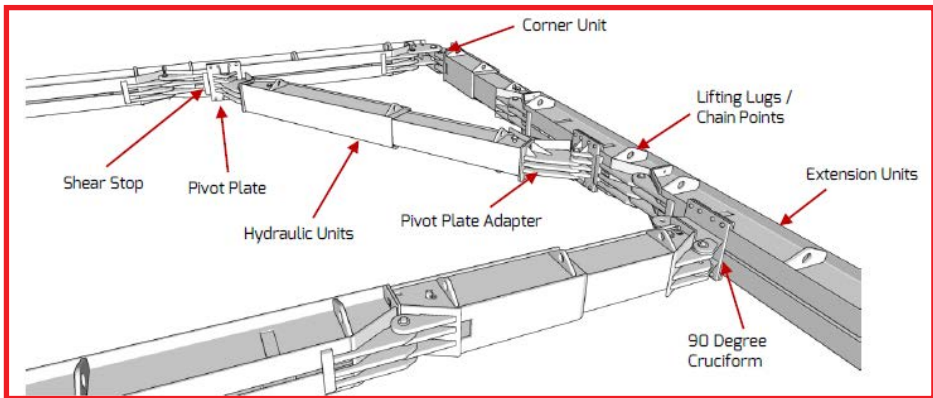



# Brace Length Chart

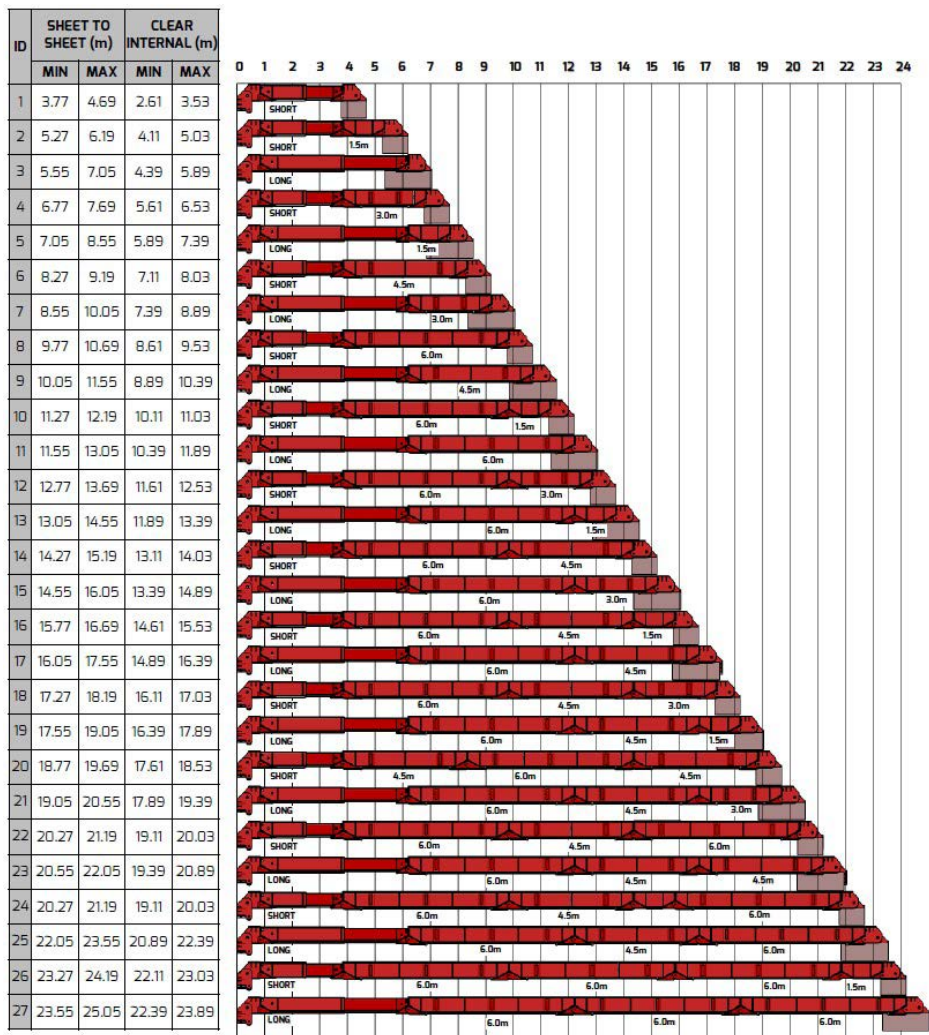

The above configurations are a guideline. Where possible it is good practice to keep joints away from high sagging and hogging moments.

Clear internal dimensions do not allow for deflections



# Mammoth Plus Components



## Hydraulic Units

Code	Product	Operating Range	Weight
<b>087201</b>	Short Unit	2080mm - 3000mm	1384kg
<b>087200</b>	Long Unit	3660mm - 5360mm	2467kg



## Extension Units

- 100ø lifting eye/chain point.
- Lugs connected with single 50ø pin.

Code	Length - End To End (Plate)	Weight
<b>087210</b>	1000mm	382kg
<b>087215</b>	1500mm	382kg
<b>087230</b>	3000mm	573kg
<b>087245</b>	4500mm	981kg
<b>087260</b>	6000mm	1308kg



## Corner Units

- Corner pieces connected with single 80ø pin.
- Single 50ø pin to Hydraulic/Extension units.

Code	Weight
<b>087290</b>	261.10kg



## 90 Degree Cuciform

- Flange hanging plate.
- Single 50ø pin to Hydraulic/Extension units.
- M24 Bolts Gr 8.8

Code	Weight
<b>087292</b>	231.10kg

# Mammoth Plus Components



## Pivot Plate

- Flange hanging plate.
- 50ø pin to pivot plate adapter
- M24 Bolts Gr 8.8

Code	Weight
<b>087291</b>	200.00kg



## Pins

Code	Description	Weight
<b>087293</b>	50ø Pin	3.00kg
<b>087294</b>	80ø Pin	4.00kg

## Components

Full Assembly and Installation Guidance can be found separately.

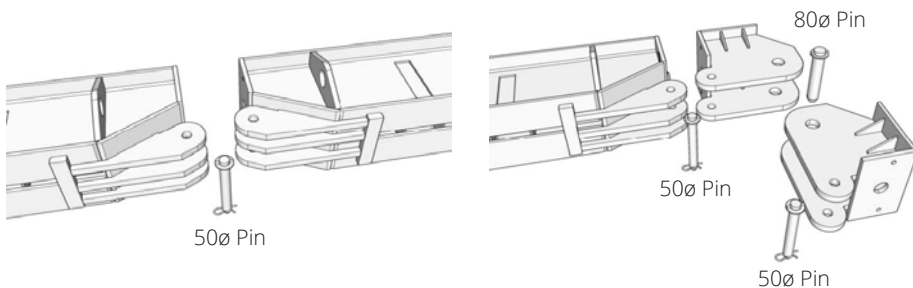



## Trench Sheeting - Available Nationwide

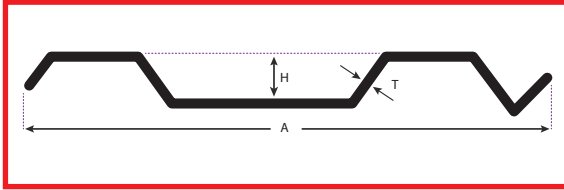

### Standard Overlapping

**Code - 115**

Overlapping profile in mild steel, available in lengths from 2m to 5m.

A (mm)	Effective Width Per Sheet	H (mm)	T (mm)	Kg/m	Kg/m <sup>2</sup>
350	330	35	3.4	10.86	32.91

Section Modulus Per Sheet	Section Movement Knm/m	Available Lengths
15.93	7.75	2000mm - 5000mm

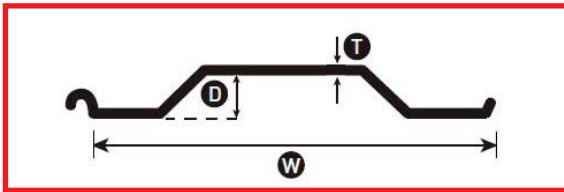

### KD 4 Sheet Overlapping

Steel Grade	Width (mm)	Depth (mm)
S 275 JR	400	50

Thickness (mm)	Weight (kg/m)	Section Modulus Z (cm <sup>3</sup> /m <sup>2</sup> )
6.0	21.90	40.34

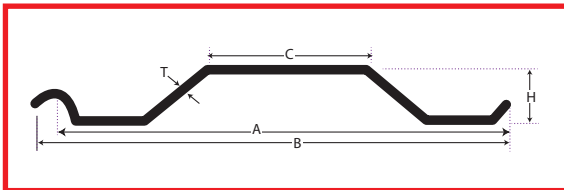

### BD500 Overlapping

**Code - 245**

Overlapping profile in high yield steel, available in lengths from 3m to 7m.

A (mm)	B (mm)	C (mm)	H (mm)	T (mm)	kg/m	kg/m <sup>2</sup>
508	552.9	220	50	6	27.74	54.61

Section Modulus Per Sheet	Section Modulus cm <sup>3</sup> Per Metre	Bending Movement Knm/m	Available Lengths
51.25	100	36.41	3000mm - 7000mm





## Trench Sheet piling - Available Nationwide

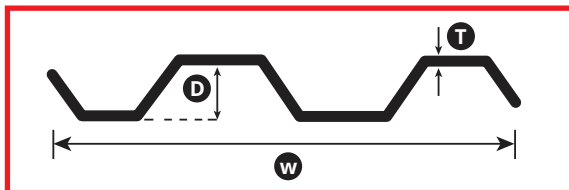

**KKD 600 Sheet Overlapping**

Steel Grade	Width (mm)	Depth (mm)
S 275 JR	600	80

Thickness (mm)	Weight (kg/m)	Section Modulus Z (cm <sup>3</sup> /m <sup>2</sup> )
6.0	37.40	179.0

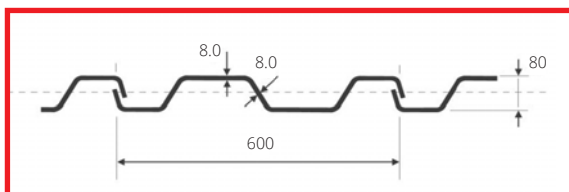

**KD6-8 Overlapping**  
Code - 260

Sectional Area (cm <sup>2</sup> )	Mass Single Pile (kg/m)	Mass Per m Wall (kg/m <sup>2</sup> )	Moment of Inertia (cm <sup>4</sup> )	Elastic Section Modulus (cm <sup>3</sup> )	Radius of Gyration (cm)
64.44	50.00	83.33	968.00	242	3.00



## Trench Sheeting - Available Nationwide

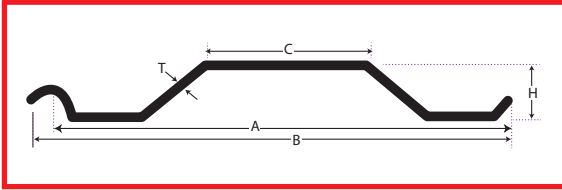

### HD2 Overlapping

**Code - 215**

Overlapping profile in high yield steel, available in lengths from 3m to 8m.

A (mm)	B (mm)	C (mm)	H (mm)	T (mm)	kg/m	kg/m <sup>2</sup>
742	764	267	90	8	54.17	73.01

Section Modulus Per Sheet	Section Modulus cm <sup>3</sup> Per Metre	Bending Movement Knm/m	Available Lengths
187.91	253.25	59	3000m - 8000m

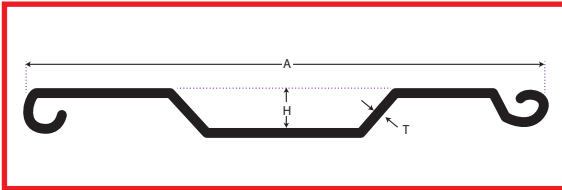

### L8 Interlocking

**Code - 120 (Sale Only)**

Interlocking profile in mild steel, available in lengths from 1m to 5m.

A (mm)	Effective Width Per Sheet (Mm)	H (mm)	T (mm)	Kg/m	Kg/m <sup>2</sup>
460	432	35	3.4	14.52	33.61

Section Modulus Per Sheet	Bending Movement Knm/m	Available Lengths
22.23	8.22	1000mm - 5000mm

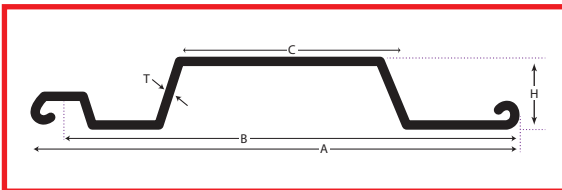

### BVI500 Interlocking

**Code - 395**

Overlapping profile in high yield steel, available in lengths from 3m to 8m.

A (mm)	B (mm)	C (mm)	H (mm)	T (mm)	kg/m	kg/m <sup>2</sup>
535.2	494	230.6	75	6	33.53	67.88

Section Modulus Per Sheet	Section Modulus cm <sup>3</sup> Per Metre	Bending Movement Knm/m	Available Lengths
43.11	91.863	50.3	3000mm - 8000mm



## Trench Sheet Piling - Available Nationwide

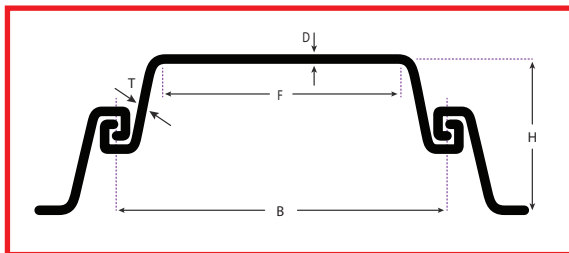

Available Nationwide

Larsen Range  
Interlocking

Altrad Generation Steel Sheet Piles are used for permanent and temporary works structures. The section of the pile interlocks producing a continuous wall with a succession of closely fitting joints. A range of corner and junction piles are available to suit all requirements.

Section	L601	L602	L603	L604	L605	L606	L607
B (mm)	600	600	600	600	600	600	600
H (mm)	310	310	320	390	420	420	435
D (mm)	7.5	8.2	9	9.5	10	16.5	21.5
T (mm)	6.4	8	9	9.5	10	9.2	9.8
F Flat Of Pan (mm)	253	250	384	382	367	348	380
Sectional Area (cm <sup>2</sup> /m)	98.3	115.4	137.6	157.3	174.9	201.3	243
Kg/m	46.3	54.3	66.5	74.2	82.4	94.8	114.4
Kg/m <sup>2</sup>	77.2	90.5	110.8	123.5	137.5	158	191
Combined Moment Of Inertia (cm <sup>4</sup> /m)	11496	13075	20178	32599	42420	52,631	69600
Section Modulus (cm <sup>3</sup> /m)	742	845	1261	1671	2020	2506	3200

Altrad Generation also supplies Piling Hammers, Pipe Lifters. Call all our excavation safety experts on **0800 779 7113** or email [groundworks.enquiries@altradgeneration.com](mailto:groundworks.enquiries@altradgeneration.com) to discuss your project requirements.

### Piling Hammers



### Probst Pipe Lifters





## Groundwork Ancillaries



### Manhole Shutters

Modular Steel Shutters used to form concrete surround around Manhole Rings in situ. Combination of three panel sizes allows great flexibility on site to cover all Manhole Ring sizes ranging from 675mm to 3000mm diameter and available in two heights: 900mm and 1800mm.

Diameter of Manhole (mm)	Thickness (mm)	Number of Sections Required to Form Shutter			External Diameter of Concrete (mm)	Theoretical Thickness of Concrete (mm)	Volume of Concrete Surround (m <sup>3</sup> )	
		A	B	C			900	1800
675	65	2	1	0	1171	182	0.51	1.02
900	75	2	2	0	1368	159	0.54	1.09
1050	85	3	0	1	1541	160	0.63	1.25
1200	100	3	1	1	1738	169	0.75	1.50
1350	112	3	2	0	1855	141	0.68	1.36
1350	112	3	2	1	1935	181	0.90	1.80
1500	115	4	0	1	2028	150	0.79	1.58
1500	115	4	0	2	2107	189	1.02	2.05
1800	115	4	2	0	2342	156	0.96	1.93
2100	120	5	1	0	2632	146	1.03	2.05
2100	120	5	1	1	2712	186	1.33	2.66
2400	135	6	0	1	3002	166	1.33	2.66
2700	162	6	2	0	3316	146	1.31	2.62
2700	162	6	2	1	3396	186	1.69	3.38
3000	210	7	1	1	3686	133	1.34	2.68
3000	210	7	2	0	3800	190	1.94	3.89

Height (mm)	Weight Of Sections (Kg)		
	A	B	C
900	27.5	12.5	6
1800	55	25	12

Product Codes	A	B	C
900 Model	<b>085291</b>	<b>085292</b>	<b>085293</b>
1800 Model	<b>085204</b>	<b>085205</b>	<b>085206</b>

## Groundwork Ancillaries



### Manhole Safety Platform

Code	To Suit Manhole Ring Dia. (mm)	Weight
<b>085207</b>	1200	211kg
<b>085208</b>	1800	402kg
<b>085209</b>	2400	549kg



### Driving Caps

Driving Caps are used with Altrad Generation Trench Sheets to minimise damage to the sheet during driving.

Code	Driving Caps	Weight
<b>140001</b>	Universal	8.00kg
<b>140005</b>	BD	20.00kg
<b>140004</b>	HD	25.00kg



### Hydraulic Installation Kits

Double acting Hydraulic Installation Kit for use with Altrad Generation hydraulic shoring equipment such as Alloy Waler Systems and Manhole Braces.

Code	Kit Component	Weight
<b>085120</b>	Double Acting Pump	12.00kg
<b>085126</b>	Male Manifold	2.00kg
<b>085127</b>	Female Manifold	2.00kg
<b>085124</b>	6m Female Hose	7.00kg
<b>085125</b>	6m Male Hose	7.00kg
<b>089198</b>	1 Litre Shoring Fluid (Sale Only)	n/a



# Groundwork Ancillaries

## Lifting Equipment



### Quick Release Pitching Shackle

Used to install Altrad Generation Trench Sheets, our quick release Pitching Shackle uses a spring loaded pin and release system to grip the Trench Sheet through the Trench Sheet's lifting hole. The sheet can then be driven into position.

Code	Product	SWL (Tonnes)	Weight
<b>083002</b>	2t Quick Release	2	19.00kg
<b>083003</b>	3t Quick Release	3	23.00kg

## Four Leg, Hanging & Snatch Chains



The Four Leg Lifting Chain is used to safely lift all shoring equipment. Our wide range of lifting chains are all fully LOLER compliant and come supplied with all relevant certificates.



The Hanging Chain is used to hang hydraulic support from Trench Sheets.



The Snatch Chain is used to safely extract all shoring equipment. Snatch Chains are fully LOLER compliant and come supplied with all relevant certificates.

Code	Product	SWL (Tonnes)	Length (m)	Weight
<b>083012</b>	Four Leg Waler Chain	3.15	4	30.00kg
<b>083010</b>	Four Leg Lifting Chain	6.7	4	45.00kg
<b>083007</b>	Four Leg Lifting Chain	6.7	6	65.00kg
<b>083015</b>	Two Leg 13mm Lifting Chain	7.5	7	63.00kg
<b>083011</b>	Heavy Duty Hanging Chain	N/A	2	3.00kg
<b>083013</b>	Snatch Chain	8	1.5	18.00kg

## Groundwork Ancillaries



### Extraction Clamps

Used to extract Altrad Generation Trench Sheets, note that Extraction Clamps should never be used to pitch Trench Sheets.

Code	Product	SWL (Tonnes)	Weight
420007	Extraction Clamp	5	25.00kg
420008	HD Extraction Clamp	7.5	30.00kg



### Trench Safety Covers

Our range of Trench Safety Covers are ideal for protecting against falls when working on pavement excavations.

Product	Thickness (mm)	Width (mm)	Length (mm)	Weight	Weight Tested (kg)
Safe Cover 16/12	25	1600	1200	33.00kg	Up to 2000
Safe Cover 12/8	30	1200	800	12.00kg	Up to 2000
Trench-Pro	30	1000	1100	15.00kg	Up to 2000



### Elite TrenchCross™

The strongest, lightest and most versatile trench cover that provides the complete site solution.

- Detachable handrails
- Easy to lift
- Anti-slip
- Reflecting film
- Handles
- Can be fastened to the ground
- Anti-slip caps
- Full plastic frame

Code	Product	Width (mm)	Length (mm)	Weight	Maximum Load (kg)
081872	Elite TrenchCross™	100	170	20.00kg	1000



# Ground Protection

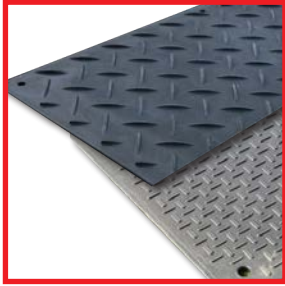

## Ground Guards

Ground-Guards provides temporary ground protection, traction and access over sand, mud, marshy areas whilst protecting your personnel, equipment, vehicles and turf.

It is a simple and very easy to use system. When locked in place Ground-Guards form temporary roadways and car parks for vehicles and trucks as well as solid surfaces for events, drilling, civil engineering and other industrial applications.

- Lightweight mats are easy to move around using the Handy-Hook and easy to lay by hand
- Quickly connect together using No-Tools joiners
- Life time guarantee against breakage by vehicles up to 120 tonnes (conditions apply)\*
- Eliminate cost of continually replacing slippery splintered plywood boards
- Super tough 100% recycled poly-ethylene plastic 1/2" thick – flexible enough to conform to ground contours

### Relocatable roadway gives rapid site access

A Ground-Guard trackway is the smart solution for your rapid site access requirements. It protects your ground and turf, minimises reinstatement costs, prevents vehicles getting bogged down, keeps your jobs on schedule, and keeps your workers SAFE!

### Why get bogged down without Ground-Guards?

Weighing only 39kg, the panels can be installed by hand without a crane lorry, yet are so tough that they are guaranteed unbreakable by vehicles up to 120 tonnes making them ideal for manoeuvring heavy equipment around on site with minimal disturbance to the turf.

Code	Core Thickness	Width (mm)	Length (mm)	Weight (kg)
460010	14	1217	2433	39.00kg

Loading Rating	Material	Traction
Unbreakable by vehicles up to 120 tonnes*	100% recycled HDPE. Resistant to acids, alkalis and solvents	Patented ribbed tread pattern provides extra traction and stiffness, without additional weight

\*Ground-Guards are guaranteed when used by vehicles up to 120 tonnes. The guarantee does not extend to damage caused by lifting the Ground Guard by mechanical means or damage due to misuse. Note, it is the customer's responsibility to assess the load bearing capacity of the ground and determine what weight of vehicle it is capable of safely supporting. Traversing of steel tracked vehicles will damage the tread of the Ground Guard and may result in damage charges. To prevent damage, the Ground Guard should be laid pedestrian side up if steel tracked vehicles are to be traversed. Operation in straight lines is permitted.



## Ground Protection

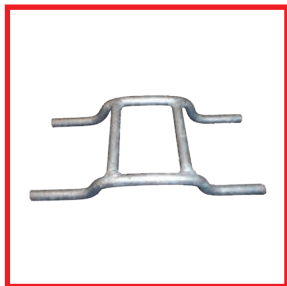

<b>Code</b>	<b>460011</b>
<b>Desc.</b>	Double Joiners
<b>Wt.</b>	0.74kg

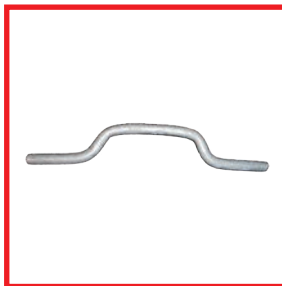

<b>Code</b>	<b>460012</b>
<b>Desc.</b>	Single Joiners
<b>Wt.</b>	0.26kg



<b>Code</b>	<b>460013</b>
<b>Desc.</b>	Ground Anchor
<b>Wt.</b>	0.90kg



<b>Code</b>	<b>460014</b>
<b>Desc.</b>	Handy Hook
<b>Wt.</b>	0.96kg

### How to avoid damaged turf

Planning the use of Ground-Guards into your job before you start can save you from ruining your turf, and the extra safety that they provide could also save someone from having a serious accident.

Ground-Guards feature a patented diamond design giving the maximum traction in the wet and dry as well as reducing sideways movement and slippage. They have now become recognised as standard equipment for use on many sites. This is largely due to the fact that they are virtually indestructible.

The use of a geo-textile membrane is recommended where the ground guard will be used in very wet conditions, long term applications or where heavy vehicles will be used.

### 1 Load of Ground-Guards = 32 Loads of Stone!

A large arctic lorry can hold 500 Ground-Guards. Enough to make a 600m roadway. To do that in stone, 3m wide and 250mm deep requires excavating and shifting 450m<sup>3</sup> of earth and bringing in approximately 32 x 25 tonne lorry loads of stone. Then reversing the whole process afterwards. 64 lorry journeys compared to 2 for Ground-Guards!





# Ground Protection



## Road Mats & Plates



- Easy to install ground protection for pedestrians, planes and vehicles up to 80 tonnes.
- Fast, temporary access, working areas and trackways.
- Unique non-slip reflective markings for night safety (optional).
- Unique 'Cats Eyes' reflectors for night safety (optional).
- Save time and money in reinstating ground.
- Made from 100% recycled High Density Polyethylene (HDPE) reduces landfill waste and cost.
- Avoid severe rutting eco damage to environmentally sensitive areas.

Products	Roadmat Light	Road Plate Oxford 15/5	Endura Mat Large	Endura Mat Small
Thickness (mm)	14	12	12	12
Width (mm)	1200	500	1220	1220
Length (mm)	2400	1500	2440	1220
Weight (kg)	35	32	32	16
Weight Tested (Tonnes)	Up To 60	Up To 40	Up To 80	Up To 80
Material	100% Recycled Hdpe	-	-	-
Traction	High Definition Chevron Traction System	-	-	-
Connectivity	Various Steel And Hdpe Connections Available	-	-	-

# Ground Protection

## Road Plates



### Steel

- 3/4" Steel plate
- 4 Lifting holes per plate
- Available in sizes 8' x 4' and 6' x 4' with or without an anti-skid coated surface
- Anchor holes after coated surfaces

### Anti Skid Coating

Chinese bauxite 1-3mm size aggregate coating supplied by Jobling Purser. Type 1 BBA Approved high friction surface combining a two part polyurethane resin technology with a high PSV calcined bauxite road grade aggregate.

Code	Product	Weight
<b>420110</b>	8' x 4' x 3/4" Steel Road Plate	420kg
<b>420115</b>	6' x 4' x 3/4" Steel Road Plate	315kg
<b>420112</b>	8' x 4' x 3/4" Anti-Skid Road Plate	420kg
<b>420117</b>	6' x 4' x 3/4" Anti-Skid Road Plate	315kg



## Ground Protection



### Trenchlink

Trenchlink is a system of interlocking, ductile iron mini road plates which can be easily handled by operatives on site in order to secure a trench for the immediate passage of vehicular or pedestrian traffic. They have an integrated, permanent skid resistant surface and cannot move out of position once they have been placed over an open trench. They require no anchoring while the crew is on site and can be quickly removed for permanent reinstatement.

- Minimal traffic delays, resulting in reduced vehicle emissions.
- No temporary tar- no transport, disposal or re-cycling costs.
- Maintain traffic flow and speed
- Temporary reinstating eliminated
- Increase productivity
- Reduce costs
- Locks securely over trench
- Integrated skid resistant surface

Code	Description	Weight
<b>260191</b>	Trenchlink 500 Max Plate	26.00kg
<b>260192</b>	Trenchlink Width Adjuster	0.50kg
<b>260193</b>	Trenchlink-Adjuster Pin	0.01kg
<b>260194</b>	Trenchlink-Stillage	30.00kg

## Trench Struts



Available stock in four sizes, Altrad Generation's Trench Struts feature clawed base and head plates to enable a better grip to the trench lining and hold it tightly in place preventing collapse. All struts are manufactured to BS4074:2004 and are thread rolled to ensure there is no cutting away of material or loss of strength.

Safe Working Load (SWL) of 3 tonne at any length.

Outer Tube: 60.3mm dia / Inner tube: 48.3mm dia.

Base and Head Plate: 75mm x 75mm x 6mm

Clawed c/w 2 nail holes.

Code	Size	Height (mm)	Weight
<b>405009</b>	0	0.32m - 0.47m	4.99kg
<b>405007</b>	1	0.49m - 0.73m	6.58kg
<b>405008</b>	2	0.69m - 1.09m	8.62kg
<b>405011</b>	3	1.03m - 1.73m	8.62kg

## Roadforms

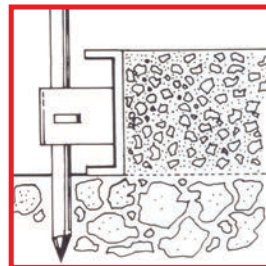
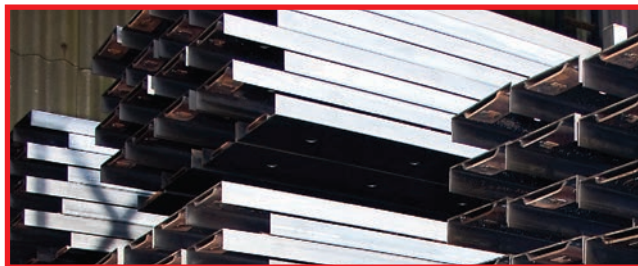

Roadforms provide a simple, robust, accurately aligned edge formwork for use when constructing ground slabs, roadways, pathways and foundations up to 300mm. Made of strong square section steel and using a series of ground stakes to secure in place. Roadforms create a smooth uniform finish to any poured concrete slab. Each Roadform is tongued to allow continuous runs.



### Square Edged

For all types of edge formwork necessary for the construction of ground slabs, roadways, foundations and footings, etc. Three welded stake housings are incorporated together with a locking tongue for accurate alignment of adjacent forms.

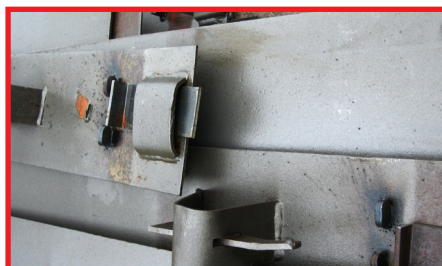

### Flexible

Used for radius work and whenever it is essential for a smooth curve. Five stake housings are incorporated to ensure accurate settings to any desired curvature. Provided with a locking tongue and designed for the use in conjunction with Altrad Generation Square Edged Roadforms.

Code	Product	Depth (mm)	Length (mm)	Weight
410006	6" Standard Roadform	150	3000	25.80kg
410008	8" Standard Roadform	200	3000	30.50kg
410009	10" Standard Roadform	250	3000	35.20kg
410010	12" Standard Roadform	300	3000	50.00kg
410016	6" Flexible Roadform	150	3000	19.50kg
410018	8" Flexible Roadform	200	3000	24.20kg
410019	10" Flexible Roadform	250	3000	28.90kg
410020	12" Flexible Roadform	300	3000	46.00kg
410050	600mm x 22mm Stake	-	-	2.00kg
410055	Stake Extractor	-	-	5.00kg
410105	5 Litre Mould Oil	-	-	5.00kg



## Additional Services

### Safety

Altrad Generation offers a range of trenching equipment to ensure your excavation work is carried out using the safest equipment. No ground can be relied upon to stand unsupported in all circumstances and depending on conditions, a cubic metre of soil can weigh in excess of 1.5 tonnes. Every year people are killed or seriously injured whilst working in excavations. The law says you must prevent the risk of danger to workers in or near excavations and no work should take place until the excavation is safe.

We have a range of additional safety products we can offer, including:

#### Pipe Stopper



#### Breathing Apparatus



#### Gas Detectors



#### Winch And Harness





## Notes







# Fencing, Hoarding & Barriers

Fencing, Hoarding, Barriers & Water Filled Barriers

Temporary Fencing

Fencing Stability

Fencing Accessories

Temporary Steel Hoarding

Hoarding Stability

Hoarding Accessories

Wind Resistance Calculator

Pedestrian Barriers

Traffic Management Barriers



Wind Speed  
Tests





## Fencing, Hoarding, Barriers & Water Filled Barriers



Altrad Generation is the largest supplier of scaffolding products in the UK, we got to be in that position with a combination of providing quality products and service backed up by a knowledgeable team.

The next part of our progression was to go into the temporary fencing market with the same approach & we quickly became one of the biggest providers of this product in the UK.

To maintain our position & better service our customers on a national basis we expanded our range to include complementary products. Since doing this we are now one of the biggest suppliers of non mechanical plant including temporary fencing, pedestrian barriers, water filled barriers, hoarding, acoustic barriers, edge protection and groundworks products. With branch networks providing complete UK and Ireland coverage with their own vehicles which have FORS Silver accreditation and ample stocks of a wide variety of quality non-mechanical plant.

Our expertise and knowledge leaves us confident that we can efficiently supply the best products for your requirements making sure that you receive the best quality items at the right place, right time every time.



# Temporary Fencing

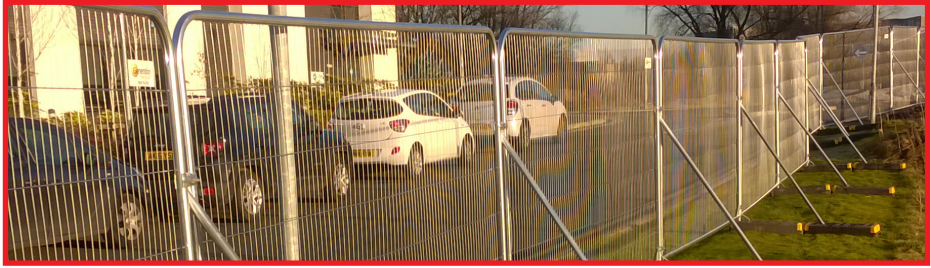

Altrad Generation are one of the biggest providers of Temporary Fencing and can offer the most effective and economic solutions for Temporary Fencing and Barriers for site boundaries. Easily locking together, both fencing and barriers can be quickly erected on site to provide a safe and secure temporary boundary. A full range of additional components can also be supplied; such as pedestrian and vehicle gates extensions and stabilisers.

All our fence panels are manufactured using SMARTWELD technology meaning that they are stronger than ever and have 100% product quality and traceability. This method of manufacture provides a 360° weld at the joins, every panel has these automatically tested to ensure that the frame can withstand a load of 500kg and only if it passes this test will it be given a batch code. However it is not only the strength of the frame that makes these panels stand out, these panels offer maximum strength as the mesh is pulled taut prior to welding for full rigidity. This process not only that the best fencing reaches you but also means that you can standardize your products. Altrad Generation fence panels fully comply with the recommendations of the guidance note HS(G)151 - Protecting the Public.

## Square Top Anti-Climb Panel

The Square Top Anti-Climb Panel is available in heavy duty, light duty, and with corner brackets. Full HSG151 compliant panel with anti-climb mesh, low profile and lightweight and easy to stack and transport. This panel has 100% product quality and traceability, with every panel tested, passed and provided with a unique ID in the factory.



Code	Description	Length	Height	Width	Weight
369040	STD Square Top Panel	3450mm	2025mm	-	13.60kg
369041	HD Square Top Panel	3450mm	2025mm	-	15.60kg



# Temporary Fencing

## HD Anti Climb Panel

A strong "industry standard" round top panel with Anti-Climb Mesh Fence Panel where security is at a premium. Fully HSG151 compliant to ensure on-site product compliance and safety. Strength, security and longevity are delivered through Smartweld technology. A 360° weld on 38mm tube with fitted corner webs. 100% product quality and traceability, with every panel tested, passed and provided with a unique ID in the factory.



Code	Description	Length	Height	Width	Weight
369039	HD Anti Climb Panel	3450mm	2000mm	-	14.00kg

## HD+ Anti Climb Panel

The heaviest and strongest round top panel with Anti-Climb Mesh Fence Panel where security is at a premium. Fully HSG151 compliant to ensure on-site product compliance and safety. Strength, security and longevity are delivered through Smartweld technology. A 360° weld on 38mm tube with fitted corner webs. This panel has 100% product quality and traceability, with every panel tested, passed and provided with a unique ID in the factory. Every single wire is welded to the frame meaning 174 individual welds.



Code	Description	Length	Height	Width	Weight
369042	HD+ Anti Climb Panel	3450mm	2000mm	-	16.00kg



# Fencing Stability



Code	Description
369102	Fence Stabiliser (HSG151) Small
369408	Stabiliser Pin



Code	Description
369100	Fence Stabiliser
369408	Stabiliser Pin



Code	Description
369100	Fence Stabiliser
369046	Standard Black Rubber Foot



Code	Description
369106	Zero Trip Stabiliser Base
369107	Zero Trip Cranked Stabiliser



## Fencing Stability



Code	Description
369403	Hoarding Stabiliser
369404	Rear Block Tray



Code	Description
369403	Hoarding Stabiliser
369404	Rear Block Tray
369446	Stabiliser Brace



Code	Description
369102	Fence Stabiliser (HSG151) Small
369408	Stabiliser Pin
369451	50kg Ballast Block



Code	Description
369450	Ballast Block Stabiliser
369451	50kg Ballast Block



## Fencing Stability



Code	Description
369443	Small Connecting Tube
369442	Windbreaker Loading Tray
369441	Windbreaker Small Footprint Stabiliser
369444	Windbreaker Zero Trip Foot



Code	Description
369403	Hoarding Stabiliser
369442	Windbreaker Loading Tray
369443	Windbreaker Connecting Tube
369444	Windbreaker Zero Trip Foot



Code	Description
369102	Fence Stabiliser (HSG151) Small
369096	Block Cradle





## Fencing Accessories



<b>Code</b>	<b>369046</b>
<b>Desc.</b>	Standard Black Rubber Foot



<b>Code</b>	<b>369044</b>
<b>Desc.</b>	Hi-Vis Rubber Foot



<b>Code</b>	<b>369048</b>
<b>Desc.</b>	Fence Coupler



<b>Code</b>	<b>369421</b>
<b>Desc.</b>	Gripper Coupler

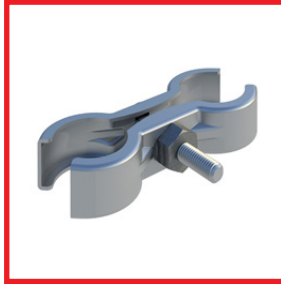

<b>Code</b>	<b>369034</b>
<b>Desc.</b>	Gripper Coupler Lite

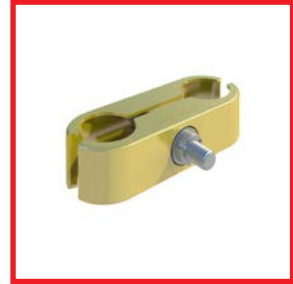

<b>Code</b>	<b>369054</b>
<b>Desc.</b>	HD Lockable Gripper Coupler



<b>Code</b>	<b>369055</b>
<b>Desc.</b>	Lockable Coupler Spanner



<b>Code</b>	<b>369049</b>
<b>Desc.</b>	Anti-Lift Device



<b>Code</b>	<b>369056</b>
<b>Desc.</b>	1m Anti-Climb RT Ped Gate





## Fencing Accessories



<b>Code</b>	<b>369057</b>
<b>Desc.</b>	4.2m Anti-Climb RT Vehicle Gate



<b>Code</b>	<b>369000</b>
<b>Desc.</b>	Fence Stillage



<b>Code</b>	<b>369104</b>
<b>Desc.</b>	Reflective Strip



<b>Code</b>	<b>071314</b>
<b>Desc.</b>	Ballast Block Lifter



<b>Code</b>	<b>369100</b>
<b>Desc.</b>	Fence Stabiliser



<b>Code</b>	<b>369102</b>
<b>Desc.</b>	Stabiliser (HSG151) Small



<b>Code</b>	<b>369408</b>
<b>Desc.</b>	Stabiliser Pin



<b>Code</b>	<b>369450</b>
<b>Desc.</b>	Ballast Block Stabiliser



<b>Code</b>	<b>369106</b>
<b>Desc.</b>	Zero Trip Stabiliser Base



## Fencing Accessories



<b>Code</b>	<b>369446</b>
<b>Desc.</b>	Hoarding Stabiliser Brace

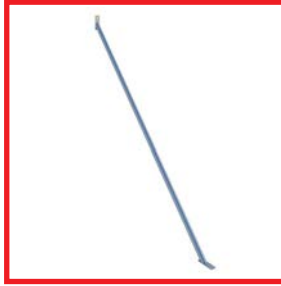

<b>Code</b>	<b>369403</b>
<b>Desc.</b>	Hoarding Stabiliser



<b>Code</b>	<b>369404</b>
<b>Desc.</b>	Hoarding Rear Block Tray

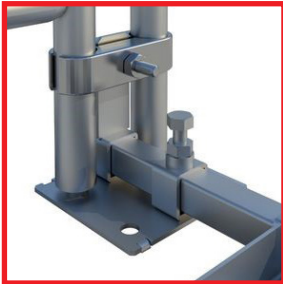

<b>Code</b>	<b>369444</b>
<b>Desc.</b>	Windbreaker Zero Trip Foot



<b>Code</b>	<b>369443</b>
<b>Desc.</b>	Windbreaker Connecting Tube

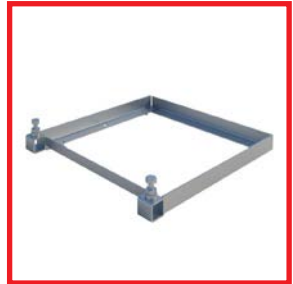

<b>Code</b>	<b>369442</b>
<b>Desc.</b>	Windbreaker Loading Tray



<b>Code</b>	<b>369441</b>
<b>Desc.</b>	Windbreaker Small Footprint Stabiliser

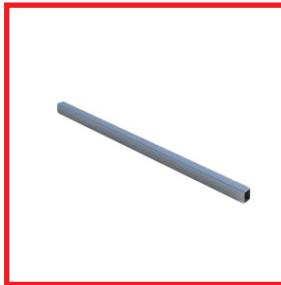

<b>Code</b>	<b>369443</b>
<b>Desc.</b>	Windbreaker Small Connecting Tube



## Fencing Accessories

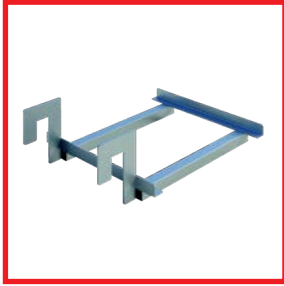

<b>Code</b>	<b>369096</b>
<b>Desc.</b>	Block Cradle

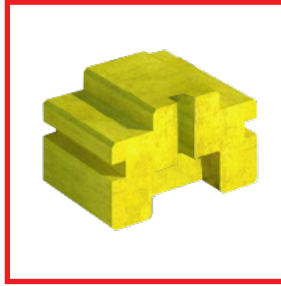

<b>Code</b>	<b>369451</b>
<b>Desc.</b>	50kg Concrete Ballast Block



<b>Code</b>	-
<b>Desc.</b>	23kg Plastic Anchor Block

## Acoustic Barrier System

Water and fire proof PVC and foam acoustic barriers that reduces site noise by 30 decibels. Increasingly important on sites to improve worker welfare and maintain community relations. Commonly used in highly populated areas where noise and proximity will cause issues and complaints i.e. city centre sites, late night work, on rail track maintenance and road works. The lightweight and roll up design makes it easy to store, transport and construct by attaching to any site fencing or scaffolding. Reflective strips for night time visibility and easy to add signage and branding. BS EN 60529 Compliant. Fixing kits available. (Use 3 Acoustic Barriers per 3.5m wide fence) Corporate branding is also available.



Code	Description	Length	Height	Width	Weight
<b>369519</b>	Echo Barrier	1200mm	2000mm	-	6.00kg



## Fencing Accessories

### Altrad Generation Slot Block

The Slot Block is a water filled stability system that can accommodate an industry standard 3.5m x 2.0m mesh panel. This space saving system has a width that is less than a standard fence foot so maximizes inner working space. Slot Block has minimum trip hazard and is flush fitting to the floor, making it ideal for schools, inner city contracts or public footpaths. It can rotate at 45 degrees to provide flexibility when setting up. Accessories include 1250 x 150 reflective strips and lights can be added for increased visibility. (2 x 1750m sections required for use with standard 3.5m size fence panel)



Code	Description	Length	Height	Width	Weight	W.Ballast
389125	Slot Block	3500mm	600mm	380mm	14.00kg	320.00kg

### Altrad Generation Rota Block Mini - For Mesh

A water filled stabilising barrier, designed to secure variable length fence panels up to 2 meters high, and can accommodate various fence lengths. The secure safety chain fastening provides stability and allows for easy adjustment where needed. The design allows it to adapt to corners, angles and uneven ground with ease. Its compact size and UV stabilized prime polyethylene construction makes it easy for transportation and handling.



Code	Description	Length	Height	Width	Weight	W.Ballast
389045	Rota Block Mini	1000mm	400mm	390mm	8.90kg	105.00kg



# Temporary Steel Hoarding



This is a portable steel hoarding system which combines the flexibility of temporary fencing with the strength & security of hoarding. These hoarding panels are available in 2 height sizes, 2.0m & 2.4m, albeit the most popular size is 2.0m. The panels come in a plain galvanized finish as standard but company livery can be achieved by painting, powder coating & /or stripes. Ideal solution to prevent unauthorised access, perimeter fencing, privacy requirements, and protection of the public and Altrad Generation provides full advice and the range of accessories to ensure the solid panelling is stable in windy site conditions.

## Hoarding Panel



Code	Description	Length	Height	Width	Weight
369419	2.0 Hoarding Panel	2140mm	1980mm	0.5mm	25.30kg
-	2.4 Hoarding Panel	2140mm	2380mm	-	30.00kg



# Hoarding Stability

## Altrad Generation Windbreaker System

Altrad Generation provide a free site wind assessment to ensure you get the right fencing and hoarding for your site. Our range of products, expert support and wind portal analysis provides will identify the right wind-breaker and stability systems for your needs.

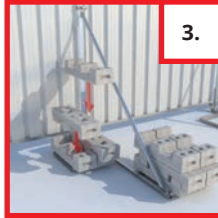
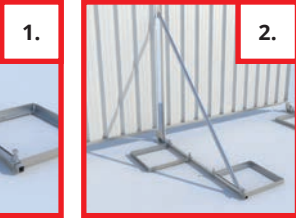
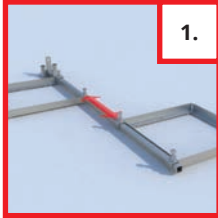

### Standard Windbreaker System

Code	Description
369403	Hoarding Stabiliser
369442	Windbreaker Loading Tray
369443	Windbreaker Connecting Tube
369444	Windbreaker Zero Trip Foot



### Compact Windbreaker System

Code	Description
-	Small Connecting Tube
369442	Windbreaker Loading Tray
369441	Windbreaker Small Footprint Stabiliser
369444	Windbreaker Zero Trip Foot



# Hoarding Stability



Code	Description
-	Big Foot Tubular Base
<b>069023</b>	Big Foot Stabiliser HD
<b>069024</b>	Big Foot Loading Tray
<b>369428</b>	Big Foot Kentledge Block (780kg)



Code	Description
-	Big Foot Tubular Base
-	Big Foot Small Footprint Stabiliser
<b>069024</b>	Big Foot Loading Tray
<b>369429</b>	Big Foot Kentledge Block (390kg)



Code	Description
<b>369403</b>	Hoarding Stabiliser
<b>369404</b>	Rear Block Tray
<b>369446</b>	Stabiliser Brace
<b>369049</b>	Anti-Lift Device



## Hoarding Accessories



<b>Code</b>	<b>369046</b>
<b>Desc.</b>	Standard Black Rubber Foot



<b>Code</b>	<b>369044</b>
<b>Desc.</b>	Hi-Vis Rubber Foot



<b>Code</b>	<b>369421</b>
<b>Desc.</b>	Gripper Coupler



<b>Code</b>	<b>369049</b>
<b>Desc.</b>	Anti-Lift Device



<b>Code</b>	<b>369416</b>
<b>Desc.</b>	Hoarding to Scaffold Coupler



<b>Code</b>	<b>369402</b>
<b>Desc.</b>	Vehicle Gate



<b>Code</b>	<b>369415</b>
<b>Desc.</b>	Pedestrian Gate



<b>Code</b>	<b>369405</b>
<b>Desc.</b>	Galvanised Infill Sheet

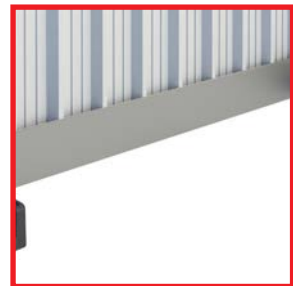

<b>Code</b>	<b>369411</b>
<b>Desc.</b>	Galvanised Infill Skirt





# Hoarding Accessories



<b>Code</b>	<b>369446</b>
<b>Desc.</b>	Hoarding Stabiliser Brace

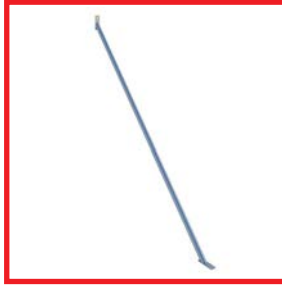

<b>Code</b>	<b>369403</b>
<b>Desc.</b>	Hoarding Stabiliser



<b>Code</b>	<b>369404</b>
<b>Desc.</b>	Hoarding Rear Block Tray

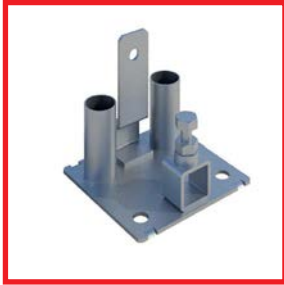

<b>Code</b>	<b>369444</b>
<b>Desc.</b>	Windbreaker Zero Trip Foot



<b>Code</b>	<b>369443</b>
<b>Desc.</b>	Windbreaker Connecting Tube



<b>Code</b>	<b>369442</b>
<b>Desc.</b>	Windbreaker Loading Tray



<b>Code</b>	<b>369441</b>
<b>Desc.</b>	Windbreaker Small Footprint Stabiliser

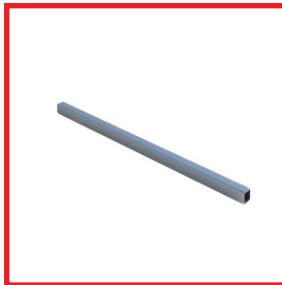

<b>Code</b>	<b>369443</b>
<b>Desc.</b>	Windbreaker Small Connecting Tube

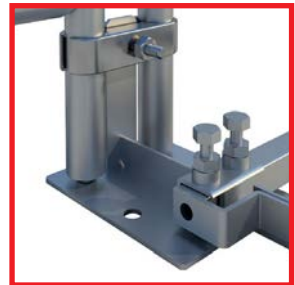

<b>Code</b>	-
<b>Desc.</b>	Big Foot Tubular Spigot Base



## Hoarding Accessories



<b>Code</b>	<b>069023</b>
<b>Desc.</b>	Big Foot Stabiliser HD



<b>Code</b>	<b>369429</b>
<b>Desc.</b>	Big Foot 390kg Kentledge Block



<b>Code</b>	<b>369428</b>
<b>Desc.</b>	Big Foot 780kg Kentledge Block



<b>Code</b>	<b>069024</b>
<b>Desc.</b>	Big Foot Block Tray



# Wind Resistance Calculator

The Altrad Generation Wind Resistance Calculator service is a technical support resource specifically designed to help sites meet the requirements of BS5975 'Temporary Works Design' relative to temporary fencing and hoarding installations.

The service provides Altrad Generation customers with guidance on the expected wind resistance capabilities of a range of freestanding fence panel products with various stability systems to help them choose the right product for safety and security for their site.

Before using the Calculator or requesting advice it is advisable to obtain your own site specific information such as prevailing wind speeds, direction of wind, location (coastal, inner city or exposed sites are more prone to the elements for example) and if a factor of safety is stipulated.

Once the site specific wind speed has been obtained you can then configure a panel and stabilisation system to match those conditions. The resistance values are approximations and are for general guidance only.

The readings in this document refer to zone D which relates to 4th fence panel or 5th hoarding panel in a continuous run. The results are based on the chosen stability method to be installed on every panel.

Note that wind-load calculation data is based on Altrad Generation product specifications and as such are only applicable to these products sourced from Altrad Generation either for hire or sale. Market alternatives may not give the same result as these readings so this document must not be used as reference to competitors products.

Please contact a member of our team, they will be able to assist in advice on which systems suit your site & provide the corresponding generic wind loading calculation.

The screenshot displays the results of a wind resistance calculation. It is divided into two main sections: 'Your Results: Windbreaker Stabiliser' and 'Your Selections'.

**Your Results: Windbreaker Stabiliser**

- Max windspeed for your configuration:** 60.11 m/s 134.45 mph
- Loading Requirement:** Front 94kg, Back 94kg
- Success:** This stabilisation meets your target wind speed. The product will be fully stabilised against the inputted wind speed.

**Your Selections**

- Target Wind Speed:** 42 m/s
- Factor of Safety:** 1.0 (0%)
- RT38 Anticlimb:** 07052232
- Windbreaker Stabiliser:** (Image of the stabiliser system)

The central part of the interface features a 3D illustration of a white fence panel supported by a metal stabiliser system. Two blue icons with downward arrows and a weight symbol are positioned at the base of the stabiliser legs, indicating the required loading.



# Pedestrian Barriers

## Fixed Leg Barrier

Altrad Generation barriers have a strengthening bar between the legs which stop them splaying and improves longevity. The fixed feet have a domed finish to make them crush resistant and safer should they be pushed over. Each barrier has 2 locking hooks to stop unauthorised dismantling on site. This barrier is supplied in a standard galvanised finish, but can be powder coated in any RAL/ BS colour at an additional cost. For windloading a 16kg ballast block can be used.



Code	Description	Length	Height	Width	Weight
368009	Fixed Leg Barrier Galv	2262mm	1100mm	-	10.60kg
368012	Fixed Leg Barrier Red	2262mm	1100mm	-	10.60kg
368013	Fixed Leg Barrier White	2262mm	1100mm	-	10.60kg

## Bar Barrier

This barrier is a galvanised steel loose Bar Barrier can be used with either a double flat foot to reduce trip or a thermo plastic foot. This barrier is ideal for easy transportation and storage. Strong and versatile, galvanised and fully interlocking.

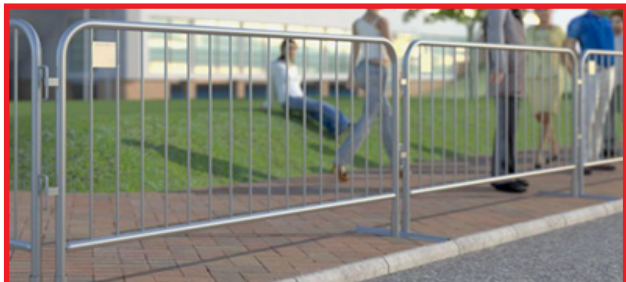

Code	Description	Length	Height	Width	Weight
368008	Bar Barrier	2300mm	1100mm	-	10.60kg



# Pedestrian Barriers

## Fixed Leg Walkthrough (Available w/wo gate)

Provides a safe access point for pedestrians in conjunction with Crowd Control Barriers. It is interchangeable with the 2.3m Fixed Leg Bar Barrier & supplied in red for easy visibility. For better safety on site it is recommended that these are supplied with the self closing gate.



Code	Description	Length	Height	Width	Weight
368005	Fixed Leg WT	2266mm	2143mm	-	12.90kg
368011	Fixed Leg WT & Gate	2266mm	2143mm	-	18.70kg

## Related Products



<b>Code</b>	<b>369046</b>
<b>Desc.</b>	Standard Black Rubber Foot

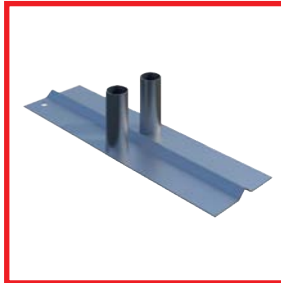

<b>Code</b>	<b>368001</b>
<b>Desc.</b>	Double Metal Foot

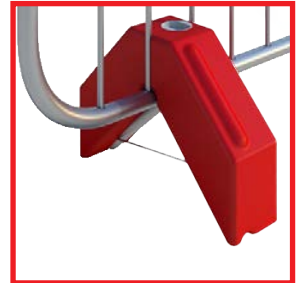

<b>Code</b>	<b>369451</b>
<b>Desc.</b>	16kg Barrier Ballast Block



# Pedestrian Barriers

## Chapter 8 Barriers

Complies with BS7818 making it ideal for event management and pedestrian control. Linking system design creates secure joints on even or uneven terrain. Constructed from tough, high density polythene (HDPE). Designed for secure stacking and easy transportation. Compliant with Chapter 8 street works. Available with Anti-Trip foot options. \*Other colours available on request, company branding also available.

### Gate & Firmus Barrier



Code	Description	Length	Height	Width	Weight
369430	Gate Barrier	2000mm	1000mm	-	9.00kg
389050	Firmus Barrier (Sale Only)	2000mm	1075mm	-	-

### Altrad Generation WonderWall™

The Altrad Generation WonderWall™ is a heavy duty barrier system that complies with Chapter 8 street works & reflectivity requirements of BSEN12899-1. This robust barrier gives stability in high winds without the need for extra ballast. It creates a safer working environment when Barrier is deployed near the road side, or excavations on site. Quick & easy to install ease by one person. To increase the height of this system to 2metres the Double Top can be added to this product.



Code	Description	Length	Height	Width	Weight	W.Ballast
389060	Wonder Wall	1140mm	1000mm	520mm	25.00kg	-



# Pedestrian Barriers

## Altrad Generation Double Top

The Altrad Generation Double Top is a multi-use barrier top designed for use on the WonderWall™ and Buddha barrier systems. Simple Hook & Eye connectivity removes the need for additional brackets associated with conventional metal tops. The Double Top is lightweight, durable and has the option for reflective on the spindles.



Code	Description	Length	Height	Width	Weight	W.Ballast
389061	Double Top	1000mm	2065mm	520mm	25.50kg	-

## Titan Barrier

The recognised and well established stacking barrier from Altrad Generation it has all the usual advantages of standard stackable systems but in addition provides many unique features. The barrier has undergone modifications to further improve longevity and to meet the proposed NRSWA changes effecting wind stability as set out in BS8442 (when erected and assembled correctly).



Code	Description	Length	Height	Width	Weight
071201	Titan Barrier 1.5m	1530mm	1005mm	-	13.50kg
071200	Titan Barrier 2.0m	1932mm	1005mm	-	14.60kg



## Traffic Management Barriers

Altrad Generation is the largest UK supplier of access, scaffolding, temporary fencing and non mechanical plant. Since adding traffic management products into our range the demand has grown extensively and we offer all types of water filled & self weighted solutions. The range varies from low level traffic separators, intermediary products that can achieve a greater height (similar to temporary fencing) heavy duty barriers and even crash tested products.

All temporary traffic barriers must be able to withstand three different classes of wind speeds with the use of a ballast. The standard BS 8442:2015 states the three classes as the following:

Class A: 26.3 m/s (58 mph)

Class B: 17.6 m/s (39 mph)

Class C: 8.7 m/s (19 mph)

Where MIRA is stated this is a physical not theoretical test where the Barrier system was filled with water and tested under strict conditions at the Full Scale Wind Tunnel at MIRA to determine at which wind speeds the barrier can withstand. If the barrier is to be a crash tested product it must be free standing at 50Mph (80KMph) to conform with BS EN1317-N. The RB22 Barrier is the "Highest Approved Plastic Barrier" system on the UK Highways approval list. One piece moulded crash barrier system that will bring a car to a controlled stop.

### Evo Barrier

Versatile and variable height barrier system that creates a solid wall when linked together for traffic demarcation and pedestrian safety. The Evo design allows the 2 different sizes to interlock and deliver barrier protection at variable heights. Fully stackable to make them easy to transport and store with a high barrier to pallet ratio and full load quantities. Constructed in UV stabilized prime polyethylene and water/sand filled to provide more stability where longer term use is required. Fast and easy to assemble on site with no additional lifting equipment required. Compatible to fit reflective post, plank or mini mesh panels.



Code	Description	Length	Height	Width	Weight	W.Ballast
369510	1.0m Evo Barrier	1000mm	555mm	400mm	6.00kg	26.00kg
369515	1.5m Evo Barrier	1500mm	555mm	400mm	10.00kg	30.00kg
369511	1.0m Evo Mesh Top	-	-	-	-	-
369516	1.5m Evo Mesh Top	-	-	-	-	-





# Traffic Management Barriers

## Pyramid Barrier

This traffic separator comes in red and white finish as standard but can be produced in corporate colours if required, dependent upon quantity. This low level barrier is unique in the way that it rotates a full 90 degrees without the need for specialist items, this enables contractors to literally 'box off' projects. Stackability is no issue and is compatible with most of the existing barriers available on the market. A 455mm mesh topping is available to an overall height of 1m. This barrier is an alternative to the 1.0m Evo Barrier and is compatible with the Mini Mesh Panel.

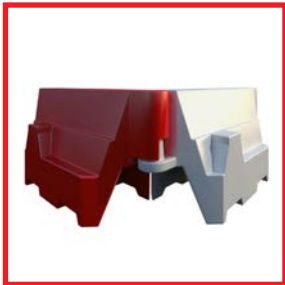

Code	Description	Length	Height	Width	Weight	W.Ballast
389111	Pyramid Barrier	1000mm	560mm	400mm	5.00kg	55.00kg

## Novus Barrier

Made from prime UV stabilised MDPE, the Novus Barrier is an excellent option for creating a safe, highly visible temporary working area or site. It is robust and adaptable and when used with mesh panels for added height, it provides a secure division between workers, vehicles, pedestrians and hazardous zones. The Novus is available in various colours and has the option of adding reflective strips for increased visibility.



Code	Description	Length	Height	Width	Weight	W.Ballast
369433	Novus Barrier	2000mm	800mm	520mm	25.00kg	180.00kg
369434	Novus Mesh Top	-	-	-	-	-



# Traffic Management Barriers

## RB2000 Barrier

For complete road, site safety and security a 1m high heavy duty low level containment barrier. Its five-position unlocking system makes it highly flexible and it flows around corners and uneven surfaces. Constructed in UV stabilized prime polyethylene it weighs up to 400kg when filled to create a solid secure system. Anti-climb mesh and hoarding panels can be added to increase height and security. Compatible with Infill, pedestrian gate and vehicle gate. Front and end stops to prevent trip hazard and improve pedestrian safety.

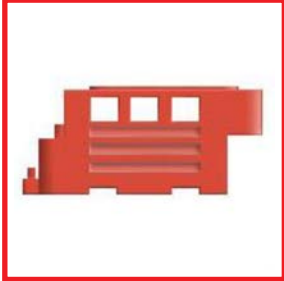

Code	Description	Length	Height	Width	Weight	W.Ballast
<b>389010</b>	RB2000 Barrier	1650mm	1000mm	400mm	35.00kg	400.00kg

## GB2 Barrier

Ideal product for highway or site delineation for pedestrian & vehicle safety. A robust heavy duty adaptable barrier system suitable for low level demarcation.

This barrier has a 2 metre working length and height of 0.9 metre with a pin locking device which allows each barrier to have a 35 degree configuration to adapt to angles and curves. Fully stackable for transport and storage. Anti-climb mesh and hoarding panels can be added to increase height and security.

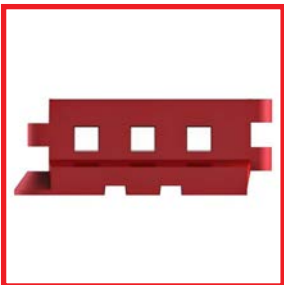

Code	Description	Length	Height	Width	Weight	W.Ballast
<b>389020</b>	GB2 Barrier	2000mm	900mm	500mm	32.00kg	350.00kg



# Traffic Management Barriers

## Bison Barrier

The Bison Barrier is a water filled barrier ideal for designating safe routes for pedestrians and vehicles. Fully stackable with an anti-slide feature for transportation and storage. Available in red and white with Chapter 8 compliant reflective strips fitted as standard for greater visibility & safety. Designed using a pin locking system which allows a 90-degree angle between barriers so that multiple configurations can be created to suit site constraints which makes it the ideal product for inner city projects where space is at a premium. Solid hoard or mesh panels can be added to the top of these barriers to increase security. This barrier is an alternative to the GB2 Barrier.



Code	Description	Length	Height	Width	Weight	W.Ballast
389112	Bison Barrier	2000mm	1000mm	400mm	-	-

## RB22 Barrier - Crash Tested

One piece moulded crash barrier system that will bring a car to a controlled stop. Crash tested whilst free standing at 50Mph (80KMph) to conform with BS EN1317-N1. Reusable after impact if not punctured/damaged. Lighter, looks better and easier to transport than concrete equivalent and does not require heavy equipment required to load/unload and assemble. Easy to lock together in formation with quick secure pin hinge set on two flat, screw fitted, steel plates for strength, speed and ease of assembly. Constructed in UV stabilized prime polyethylene and water filled during insertion and assembly. Solid hoarding or mesh panels can be added to the top of these barriers to increase security.



Code	Description	Length	Height	Width	Weight	W.Ballast
389001	RB22 Barrier	2000mm	800mm	500mm	60.00kg	600.00kg



# Traffic Management Barriers

## Bull Barrier

The Bull Barrier is a heavy duty traffic/pedestrian separation barrier which is ideal for use in temporary (short and long term) road works where the workforce will be in close proximity to moving vehicles. The Bull Barrier is not only flexible & secure it is crash tested to EN1317 T2 W6 T2 when used with reinforcement bar. The Bull Barrier can accommodate corners by use of specially designed barrels and can be topped by half height pedestrian barriers or full height anti-climb fence panels for site demarcation.



Code	Description	Length	Height	Width	Weight	W.Ballast
389100	Bull Barrier	1500mm	420mm	500mm	48.00kg	-

## GS6 Goal Post

The GS6 Height Restriction Barrier system is a lightweight, cost effective solution to ensure full GS6 compliance. This system is fully HSE GS6 compliant and is designed to be set up bridging the access road before and after the obstacle that is being avoided. Overhead goalposts are now required by law on most construction sites, where overhead obstacles are present. They are used to ensure that adequate warning is given to drivers about overhead obstacles such as power lines and structures. These are often used around live electrical cables which is the reason why the poles are made from fibreglass so they are completely non-conductive. The GS6 kits consist of two bases which are usually weighed down, 2 telescopic non-conductive poles and 25m of bunting.



Code	Description
389120	GS6 Goal Post Set, comes with metal bases, poles & bunting
389121	GS6 Goal Post Set, comes with water filled blocks, poles & bunting



## Notes



# Safety Products

Safety Harnesses

Fall-Pac Landing Bags

Air Deck







## Safety Harnesses



Altrad Generation Harnesses provide greater comfort and added safety whilst working at height. They provide maximum comfort, freedom of movement and ease-of-use leading to increased confidence, productivity and versatility on the job.

### Full Range of Safety Harnesses Available.

Please Contact Your Local Altrad Generation Branch.







# Fall-Pac Landing Bags



The Altrad Generation Fall-Pac soft landing system is designed to meet the requirements of the falls from height hierarchy of safety for fall protection by arresting falls of over 2.8 metres in standard storey height dwellings. The system can be used to protect workers fixing first floor joists and then simply moved up to the next level as required.

## Compliance

The Fall-Pac soft landing system complies with the Work at Height Regulations 2005 to reduce the risk of injury from falls up to heights of 2.8 metres. Falls from these heights, traditionally account for the largest number of injuries on building sites and any system that can reduce this risk must be seriously considered.

## Design

What makes the Fall-Pac system your best choice is that it has been designed to be both practical and hard wearing. It can be used over and over again. By adding another layer, the maximum fall height can be increased to a height of 3.5m.

## Impact Testing

The Fall-Pac modular impact cushioning system has been fully independently tested at Health and Safety Laboratories who carried out over 30 impact tests. A full report is available on request.

## Recycling

Altrad Generation are mindful of the correct and efficient disposal of Fall Arrest equipment and will take away any filled bag once they have reached the end of their life. Please call your nearest Altrad Generation branch for further details.

## Features and Benefits

- Simple to install
- Reduces injury from falls
- Reduces fall height to within current 2.0m legislation
- Approved by safety officers
- Build time saving
- Extremely light - within current HSE weight legislation
- Durable long life
- Maintenance free
- Virtually unaffected by weather conditions
- 100% recycled materials
- Low cost per plot
- Interlocking
- Can be used for other applications
- 2500mm x 644mm

Code	Description	Weight
049010	2.5m x 0.644m Fall-Pac Soft Landing Bag	6.00kg



# Fall-Pac Landing Bags



## Vehicle Trailer Falls

### A simple solution

Falls from trailers are a common problem on-site. Fall-Pac offers a simple, easy way to protect against falls, one that takes just minutes to put together.

### Flexible

Their robust, lightweight structure means they can be used anywhere, anytime, then stored away once they've served their purpose.



### Complete protection in minutes

A typical flat bed uses around 40 bags, clipped together to prevent the possibility of falling between them - a common fault with other "lorry bags"

### Minimising delay - Maximising safety

Units are light in weight and easy to install so minimising delays to work schedules. Once the work is completed the units can be easily transported to the next task.



## Fall-Pac TS2 Transport Safety System

Fall-Pac's TS2 (lorry Bag) unit is the perfect solution for unloading and loading vehicles. The revolutionary new system TS2 ensures the safety of personnel and cargo alike. With its unique interlocking system the TS2 can have as many modules connected or as few, this is all dependent upon the situation in which it is being installed.

The benefits of TS2 is that once it is in place it adds another 2.5 metres to either side of either your trailer or your dock leveller. This then gives additional surface coverage which subsequently gives personnel additional footage space which in turn will eliminate or drastically reduce the amount of stumbles, trips and falls from all application points.



### TS2 Size and Dimensions

The TS2 lorry bag covers an area of 4.5Sq. If this solution is to be used around a 40 to 44ft trailer (either curtainsider or flatbed trailer) the requirement of 3 to 5 per side with 2 at its foot. This then gives an additional 2.5 metres around the whole of the trailer and gives ultimate safety feature, which is also moveable.

Code	Length	Width	Height	Weight
Sale Only	2500mm	1800mm	1300mm	39.00kg

# AirDeck



Code	Weight	Weight
<b>025100</b>	Airdeck Airbag	4.65Kg
<b>025110</b>	Airdeck Inflator 18V	1.00Kg
<b>025111</b>	Airdeck Inflator 20V	1.00Kg
<b>025115</b>	Airdeck Inflator Battery 18V	0.39Kg
<b>025116</b>	Airdeck Inflator Battery 20V	0.39Kg
<b>025125</b>	Airdeck Charger 18V	0.37Kg
<b>025126</b>	Airdeck Charger 20V	0.37Kg

AirDeck is a fall arrest system that utilises an inflatable air cushion and is designed to protect anyone working at height.

Comprised of an inner liner which is inflated and an outer protective bag made from woven polypropylene, AirDeck is an efficient fall arrest solution.

## Features & Benefits

Durable outer polypropylene layer

Upper face is made from a double layer to provide additional protection from accidental damage.

Portable and easily stored - 50 bags will fit onto one pallet when deflated.

Easy to operate with the battery powered inflator tool.

Once inflated forms a cushioned surface 750mm from floor level and offers protection from a fall up to 2.75 metres.

Can fit into odd shapes easily.

Filled with air, so has vastly reduced fire risk compared to other soft landing systems.

## Cordless Blower



- Overall length: 565mm
- Net weight with battery and regulator: 1.7kg.
- Battery Charge Time: 60 mins Supplied with one battery. Usage from 1 x 2A battery = inflation of 25 AirDeck bags.
- Rapid inflation, each bag takes 30/40 seconds to inflate.
- Fitted with pressure regulator to ensure bags cannot be over inflated.

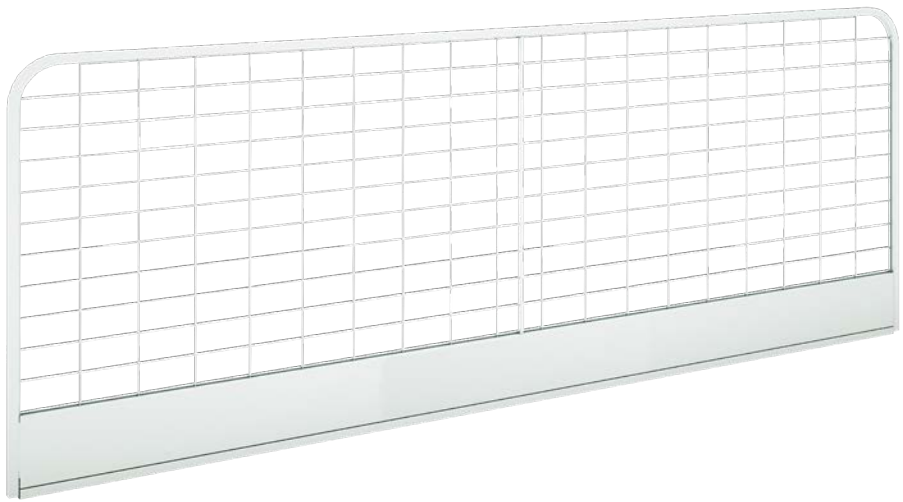

# Edge Protection

Introduction

Steel Frame Solutions

Concrete Frame Solutions

Timber Frame Solutions

Staircase Solution

Lift Shaft Solutions

Demarcation

Service & Support

Safeguard Roof Edge Protection





## Edge Protection



Altrad Generation's Rapid Edge Protection System is perceived to be one of the most comprehensive and effective systems in the market today. Designed and manufactured in the UK, our edge protection system offers a fast and efficient approach to site safety. We provide a full range of safe solutions for steel, concrete, and timber construction applications, offering huge benefits in safety, efficiency, and productivity, providing one of the quickest and most effective systems for protecting against falls from height.

All Edge Protection products are fully tested by Lloyds British test house and have been proven to meet and exceed the test requirements set out in BS EN 13374:2013 for Class A and Class B

When you source Edge Protection Solutions from Altrad Generation, you'll receive a fully comprehensive service which includes:

- Dedicated Edge Protection Account Manager: [edgeprotection@generationuk.co.uk](mailto:edgeprotection@generationuk.co.uk)
- Detailed quote with technical drawings.
- Optional additional detailed drawings, including phasing and indexing to save you time on-site
- On-site product familiarisation.
- On-site support, including installation and erection checks.
- Comprehensive installation guides.
- Edge Protection Federation accredited courses available.
- Readily available stock with our network of branches across UK.
- Fast and flexible delivery via our fleet of lorries, fitted with Hiab cranes.
- Uniformed pricing and credit facilities.

**How Does it Work?**



**Scan To View  
Our Videos.**



# Edge Protection

## Why Choose us?

### The Rapid Post

- Faster than other similar systems on the market, this revolutionary on piece post can be installed in 3 easy steps.
- 10 times faster than traditional drill and fix solutions, with no drilling required, the rapid compression post gives significant savings on time, labour with no repairs.
- The post coupled with the rapid panel gives unrivalled economics in speed off erection.
- Offering Single, double or full height Edge Protection for a variety of containment solutions.
- Anti-tamper device for increased safety

### The Rapid Panel

- This robust panel exceeds all safety standards set out in BS EN13374 : 2013 Class A & Class B.
- The biggest panel on the market today, at 2.9m, offering unrivalled fixing centres of 2.7m.
- 2.7m fixing centres covers more area, which saves on material and labour costs.
- It comes in three sizes of 2.9m 1.4m and 665m to give the flexibility required for modern building methods today.

### The Rapid Work Through Panel

- This revolutionary panel offers the safe facility to reach through the panel and access the perimeter without compromising their safety, providing increased productivity.
- The only panel of its kind on the market today.

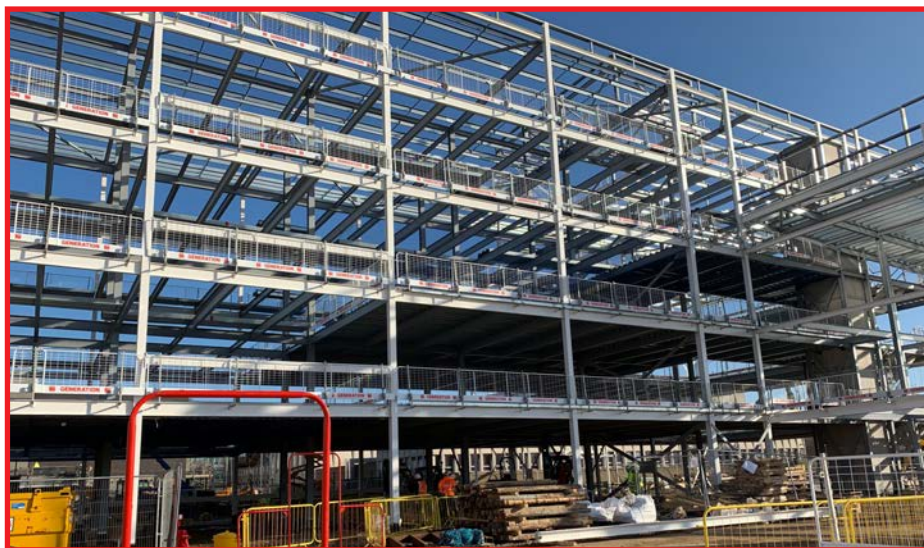



# Edge Protection

## Edge Protection Panel

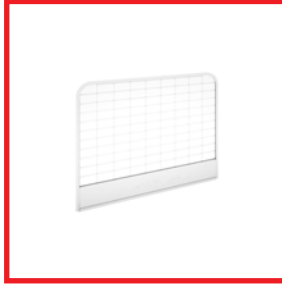

The robust design ensures that the system not only meets but exceeds all global safety standards and with unrivalled fixing centres of 2.7m.

Code	Description	Size (L X H)	Weight
<b>450064</b>	EP Panel Quarter	655mm - 1065mm	9.50kg
<b>450006</b>	EP Panel Half	1400mm - 1065mm	12.00kg
<b>450004</b>	EP Panel Full	2900mm - 1065mm	21.50kg

## Edge Protection Work Through Panel

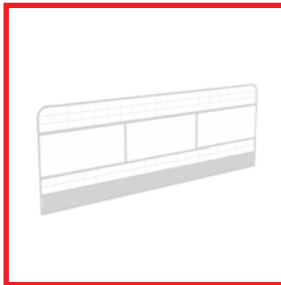

The simple but efficient patent pending barrier system provides the facility for operatives to safely reach through the panel to access the perimeter of the building without compromising their safety.

Code	Description	Size (L X H)	Weight
<b>450121</b>	Half Panel	1400mm - 1065mm	13.50kg
<b>450111</b>	Full Panel	2900mm - 1065mm	26.50kg

## System Loading Available on Request.

For added protection all new panels are shipped in purpose built stackable transportation aids to ensure the product is in pristine condition on arrival.





## Edge Protection Ltd System Testing, Class A & Class B

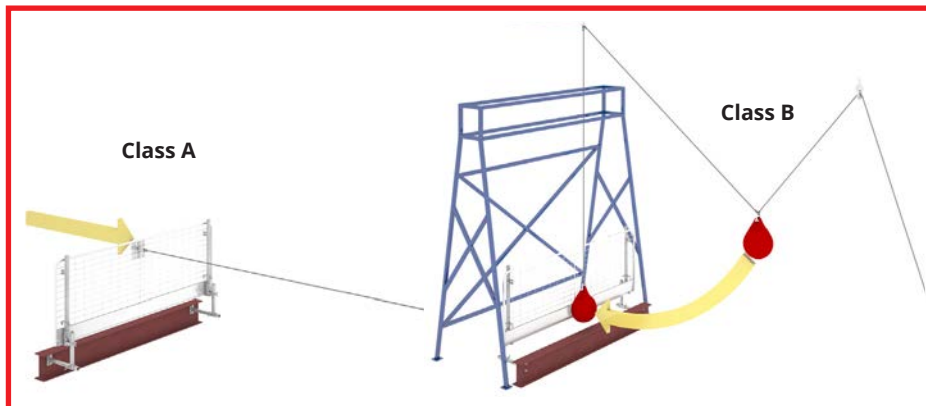

### Class A

The Edge Protection must resist a horizontal force of 0.3kN whilst maintaining elastic deflection within 55mm. The top guardrail must also accept a vertical force of 1.25kN applied as an accidental loading. The Edge Protection System has had numerous static loads applied up to four times this requirement.

### Class B

The edge protection must resist the same static loading requirements for Class A and additionally must pass a low dynamic impact test using a specifically designed test rig and impact sphere. This test applies impact energy of 0.5kJ to the top rail and 1.1kJ to the lower areas.





# Steel Frame Solutions



Altrad Generation is a leading supplier of solutions for fixing to Steel Structures. We can provide solutions that can be installed at ground level which means we can vastly reduce the risks involved with working at height. The Brackets we can supply you with are easily adjustable making it simple for following trades to continue their on-site work. Altrad Generation provides one of the longest Mesh Panels available on the UK market, we are able to offer fixing centres of up to 2.7m meaning fewer components are required which vastly reduces the installation time.



## Web Fix

The most popular method of fixing to the steel frame is by utilising the versatile web fix bracket. The bracket offers a vertical and horizontal indexing facility and positioning of the fixing holes for the bracket would be modelled by our technical team by using the most up to date software packages.

Code	Description	Size	Weight
450035	Web fix	510mm x 560mm	7.50kg



## Web Fix Brackets

Web Fix Extension Brackets increase the capabilities of the standard range from 560mm, out to 1300mm.

Code	Description	Size	Weight
450082	Web Fix Extension Bracket	200mm	1.80kg
450083	Web Fix Extension Bracket	400mm	3.20kg

## Steel Frame Solutions



### I-Beam Clamp

The solution is used for areas where web fix or sockets are not suitable or where edge protection requirements have not been considered at an earlier stage.

Again, utilising standard Barrier Panels and Support Posts, the system is fully compliant with global safety standards.

Code	Description	Size	Weight
450018	I-Beam Clamp	15mm - 665mm	12.50kg



### Bolt On Socket

The Bolt on Socket system is commonly used on steel frames and requires the steelwork contractor to bolt the socket to the top of the perimeter beam at centres specified by our technical team.

Utilising the steel frame support post and Rapid Panel, the installation can be carried out swiftly and safely at ground level.

Code	Description	Size	Weight
450099	Bolt on Socket	182mm	1.50kg

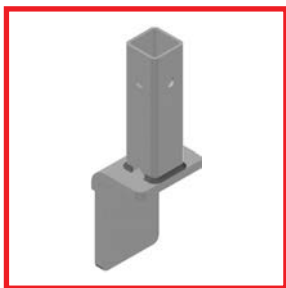

### Metsec Pocket Bracket

This simple but effective Metsec Bracket solution, has been designed to provide a quick and easy method of providing an edge protection to light-gauge steel framing systems (SFS). The system is attached to the light gauge steel using a preinstalled pocket, that the Metsec Bracket is installed into, followed by the Supporting Post and Work Through Panel.

Code	Description
450119	Metsec Pocket Bracket



### Sacrificial Socket

The Sacrificial Socket system is commonly used on steel frames and requires the steelwork contractor to weld the socket to the perimeter beam at centres specified by our technical team.

Utilising the steel frame support post and Rapid Panel, the installation can be carried out swiftly and safely at ground level.



## Concrete Frame Solutions



Altrad Generation provides edge protection solutions for concrete frames including systems that don't require any penetrating into the concrete at all. The Rapid Post is a telescopic post that offers single, extended and full containment edge protection using very few components which vastly reduces the installation process.

This unique and innovative product is proven to be up to 10 times faster than existing drill & fix systems with typically 20 metres being erected in less than 10 minutes. As well as the Rapid Post, Altrad Generation can also provide systems that drill & fix into the top of the slab, into the slab edge as well as Clamping systems.

### Rapid Post & Rapid Post Extra



#### Post:

The innovative Rapid Post, with its ease of installation and overall performance, has become a default safety solution for many companies around the world.

- 10x faster than traditional drill and fix systems.
- No tools required! No drilling or fixings.
- Minimal training required.
- Fully compliant with BSEN 13374:2013 for Class A and B Protection.
- Zero penetration of the concrete.
- Ideal for post tension slabs.
- Compression mechanism guaranteed for two million cycles.
- Safety device on post clearly indicates correct assembly.
- Single, extended or full containment edge protection for total enclosure.
- Rapid Post extends up to 3.4 metres.
- Extend height by attaching Clamps.

#### Post Extra:

Longer post extends up to 4.3 metres  
The same benefits as Rapid Post

Code	Description	Size	Weight
450001	Rapid Post	2000mm - 3400mm	12.00kg
450002	Rapid Post Extra	2900mm - 4300mm	19.00kg



## Concrete Frame Solutions



### Rapid Clamp & Latch

Add Clamps or Latches for full height Edge Protection.

Code	Description	Weight
450014	Post Clamp	0.50kg
450015	Post Latch	0.50kg



450091



450092

For added protection, all new Rapid Posts and ancillaries are shipped in purpose built stackable transportation aids to ensure the product is in pristine condition on arrival.





## Concrete Frame Solutions



### Dual Purpose Stand

The Dual Purpose Stand has been fully tested and proven to exceed global safety standards for Edge Protection/Fall Prevention. Along with a galvanised finish come:

- Installed in just minutes with two anchor bolts
- Available in standard and dual height options
- 2.7m fixing centres

Code	Description	Size	Weight
450008	Dual Purpose Stand	1120mm	6.00kg
-	Dual Purpose Stand Extra	2200mm	13.00kg



### Concrete Socket Base

The Concrete Socket Base can be installed on any concrete surface either at a pre-cast stage using inserts, or by drilling and installing later.

Code	Description	Size	Weight
450011	Concrete Socket Base	150mm	1.50kg



## Concrete Frame Solutions



### Slab Grab

A fully tested solution where Rapid Post or drill and fix solutions are precluded.

- Adjustable height on floor slabs: 150mm - 760mm thickness
- Robust tensioning facility
- Install a safe working area in minutes

Code	Description	Size	Weight
450009	Slab Grab	375mm	10.50kg



### Curb Grab

This simple but very robust solution uses the standard support post and has been tested to exceed global safety standards.

- Robust tensioning facility
- Adjustment range 150mm - 560mm
- Allows fixing to problematic areas including bridge work & parapets with upstands of up to 560mm

Code	Description	Size	Weight
450010	Curb Grab	150mm - 620mm	9.00kg







## Timber Frame Solutions



Altrad Generation provides a full range of components for hire for the timber frame edge protection. Like with our steel frame edge protection, you can install our components for Timber Frames on the ground making installation safer and more efficient. We are also able to supply you with top fix solutions and side fix solutions and handrails or mesh barriers can be used.



### Timber Socket Base

Surface fix only needs three or four fixings depending on which option you require. Fix timber socket base using 3no. Ø8/3 8 X 80mm/31 8" heco topix screw.

Code	Description	Size	Weight
450085	Timber Socket Base	181mm	1.50kg



### Universal Face Mount Bracket

Face fix only requires five Hecotopix screws into timber or alternatively can be used on concrete using 2 x M16 thunder bolts. (supplied by others). Screw 5no. 80mm/3 8" Hecotopix screws into holes.

Code	Description	Size (W X D X H)	Weight
450089	Universal Face Mount Bracket	200mm x 150mm x 100mm	1.00kg



### Dual Purpose Stand

The Dual Purpose Stand has been fully tested and proven to exceed global safety standards for Edge Protection/Fall Prevention. Along with a galvanised finish come:

Installed in just minutes with two anchor bolts  
Available in standard and dual height options  
2.7m fixing centres

Code	Description	Size	Weight
450008	Dual Purpose Stand	1120mm	6.00kg



# Timber Frame Solutions

## Handrails System

We have a selection of Handrails spanning from 280mm to 3000mm to cope with any configuration.

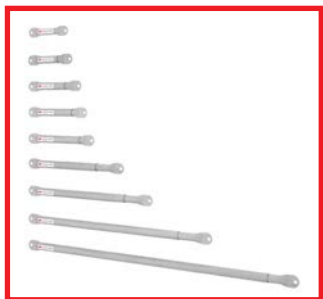

Code	Description	Size	Weight
450066	Handrails System - SR0	280mm – 300mm	1.00kg
450048	Handrails System - SR1	390mm – 440mm	1.00kg
450055	Handrails System - SR2	440mm – 500mm	1.50kg
450056	Handrails System - SR3	500mm – 590mm	2.00kg
450057	Handrails System - SR4	590mm – 720mm	2.50kg
450026	Handrails System - SR5	720mm – 930mm	3.00kg
450049	Handrails System - SR6	930mm – 1300mm	5.00kg
450025	Handrails System - SR7	1300mm – 2000mm	7.00kg
450050	Handrails System - SR8	1900mm – 3000mm	11.00kg

## Adapter Face Plate

Web fix bracket (with four fixings using adapter face plate) incremental indexing facility to cater for overhangs in excess of 900mm.

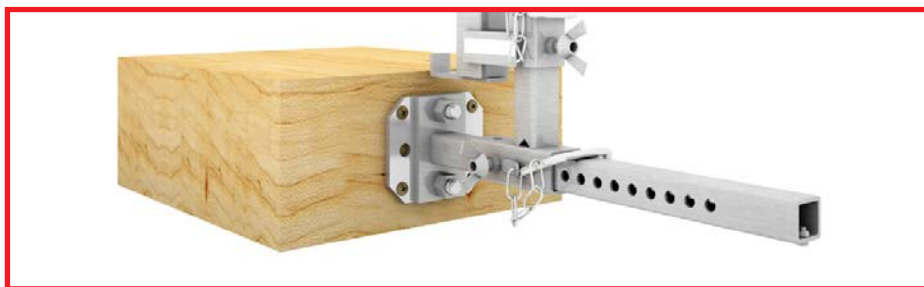

Code	Description	Size (V X H)	Weight
450034	Adapter Face Plate	140mm x 160mm	1.50kg



## Staircase Solutions



Protecting Staircases can be a challenging task as dimensions can vary. All of our Staircase solutions are supplied with unique Telescopic handrails meaning there is no need to cut down traditional tubes to the required sizes.

We can provide timber staircase and concrete staircase solution's with multiple fixing methods including drill & fix, clamping, Rapid Post & pre-cast options.

With our pre-cast and drill & fix components, we can also supply unique telescopic debris guards meaning we can offer full edge protection down the flights, landings & half-landings including returns.



### Stairwell Clamp

The Stairwell Clamp can be quickly installed on to precast stair, when drill and fix is not an option, this product is used in conjunction with the newel post and the adjustable handrail giving a speedy solution.

Code	Description	Size	Weight
450024	Stairwell Clamp	100mm – 300mm	7.50kg



### Stair Rail Connector Bracket

The Stair Rail Connector Bracket can be quickly installed on any post installed on a landing to provide handrails when speed is a necessity.

Code	Description
450027	Stair Rail Connector Bracket

## Staircase Solutions



### Newel Posts

There are 3 Stairwell Posts to suit every eventuality.

The regular Stairwell Post has antiluce fitting on a single side and the right and left posts have fittings facing out at 90 degrees.

Code	Description	Size	Weight
450021	Newel Post	1100mm	4.00kg
450022	Newel Post - Left	1100mm	4.00kg
450023	Newel Post - Right	1100mm	4.00kg



### Concrete Socket Base

The Concrete Socket Base can be installed on any concrete stair, either at a precast stage using inserts, or by drilling and installing later.

Code	Description	Size	Weight
450011	Concrete Socket Base	150mm	1.50kg

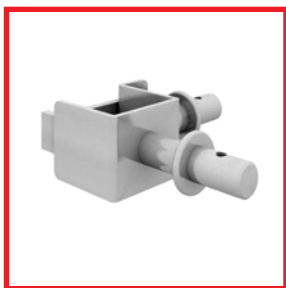

### Debris Board Connector Bracket

Code	Description	Weight
450044	Debris Board Connector Bracket	0.50kg



### Centre Post Clip

Code	Description	Weight
450054	Centre Post Clip	0.50kg



## Staircase Solutions

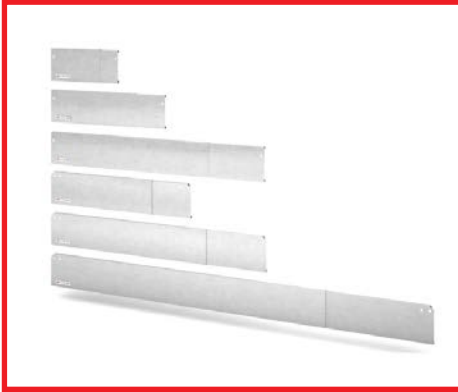

### Debris Guards – Landing & Stairs

As an added feature, most of the Edge Protection stair system can be upgraded with Debris Guards which come in a range of lengths.

Code	Description	Size	Weight
450052	Debris Guards – DGL1	390mm – 560mm	2.00kg
450058	Debris Guards – DGL2	560mm – 900mm	3.50kg
450059	Debris Guards – DGL3	900mm – 1580mm	6.00kg
450060	Debris Guards – DGL4	1580mm – 2890mm	10.50kg
450046	Debris Guards – DGS1	1320mm – 1920mm	7.00kg
450038	Debris Guards – DGS2	2940mm – 1820mm	10.50kg
450042	Debris Guards – DGS3	2820mm – 4940mm	19.00kg



# Staircase Solutions



## Stair Handrails

We have a selection of Handrails spanning from 280mm to 3000mm to cope with any configuration.

Code	Description	Size	Weight
450066	Stair Handrail - SR0	280mm - 300mm	1.00kg
450048	Stair Handrail - SR1	390mm - 440mm	1.00kg
450055	Stair Handrail - SR2	440mm - 500mm	1.50kg
450056	Stair Handrail - SR3	500mm - 590mm	2.00kg
450057	Stair Handrail - SR4	590mm - 720mm	2.50kg
450026	Stair Handrail - SR5	720mm - 930mm	3.00kg
450049	Stair Handrail - SR6	930mm - 1300mm	5.00kg
450025	Stair Handrail - SR7	1300mm - 2000mm	7.00kg
450050	Stair Handrail - SR8	1900mm - 3000mm	11.00kg

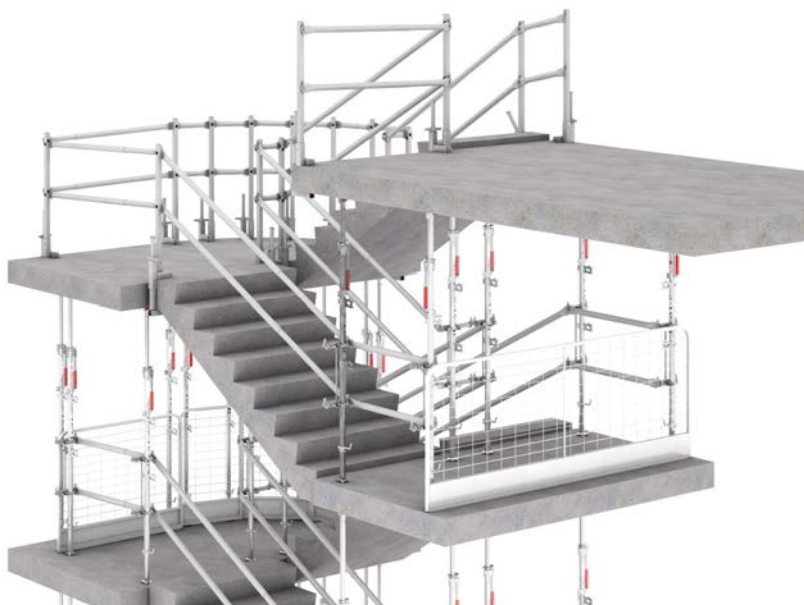



## Demarcation

Utilising the same three free standing components, safe compounds for use as waste disposal or storage areas can be created in just minutes.



### Footplate

Utilising the Hi-Vis Footplate and Standard Support Post, free standing demarcation can be swiftly installed.

Code	Description	Size	Weight
450028	Footplate	900mm - 300mm	3.00kg



### Ballast Bracket

With the addition of the Ballast Bracket and some "off the shelf" ballast blocks, you can convert EP freestanding demarcation into Class A Edge protection.

Code	Description
450084	Ballast Bracket



Free standing countered weighted Edge Protection can be installed quickly and easily by attaching the purpose designed ballast bracket to the flexible Hi-Vis Footplate.

Free standing Edge Protection systems derive their support from weighted components fixed to additional supporting systems which can be positioned on flat surfaces within at least 2 metres of the edge of a fall area.

Like all Edge Protection systems, the free standing solution has been tested at the unique 2.7m centres and has been proven to meet the requirements for a Class A system as laid down in the standard BS EN 13374: 2013.

## Safeguard Roof Edge Protection



The totally versatile, safe and easy to assemble Temporary Roofing Guardrail System that saves you time and money. Using standard scaffold tubes it provides the most cost effective solution for a professional guardrail.

Adjustable front and back legs ensure that guard rail is positioned at the correct height. When installed individual legs can be raised to accommodate felt laying and dressing with a facility for Toeboards built in.



Altrad Generation's Safeguard System is approved to the Class A requirements for sloping roofs less than 10 degrees and additionally, as an added safety measure, we have tested and fulfilled the Dynamic Load Test to Class B of BS EN 13374:2004 to give further confidence for example, in the event of a person stumbling into the barrier.

Code	Description	Weight
369300	Safeguard Frame	17.00kg
369301	Safeguard 25kg Weight	25.00kg

### Weights positioning

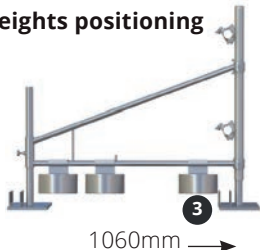

- ① Used for all bays
- ② Used for all end frames
- ③ Used for all end frames  
If the slope is  $>3^\circ$  /  $\leq 9^\circ$



## Lift Shaft Solutions



The solution utilises light but extremely robust and user friendly components and features a secure key activated locking gate. Standard EP components such as the innovative Post and Panel are utilised when completely securing the protected areas and with no need for any penetration of the working surface, multiple lift / elevator shafts are protected in just minutes.



### Lift Shaft Gates

The unique Lift Shaft/Elevator Gate offers protection to multiple core openings with just one Lift Shaft/Elevator Gate. As with all EP components, the Lift Shaft / Elevator Gate has been certificated by Lloyds British in line with BS EN 13374:2013.

Code	Description	Size	Weight
450033	Lift Shaft Gate	2240mm - 700mm	38.00kg

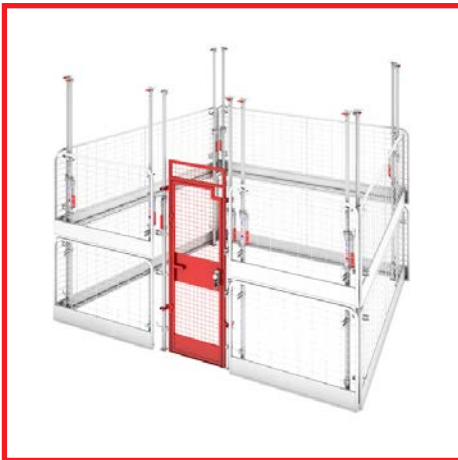

### Offering a Whole New Approach to Lift Shaft/Elevator Safety

Using standard EP components, in conjunction with a Lift Shaft/Elevator Gate, a secure compound can be built to protect valuables and control access.





## Access Gate Solutions



### Access Gate - Socket Base

A gate which can be dropped into Adjustable Slab Edge brackets and provides safety during access to the construction zone, complete with an auto-closing mechanism and Rapid Latch which secures the gate when shut.

Code	Description	Weight
450032	Access Gate - Socket Base	23kg

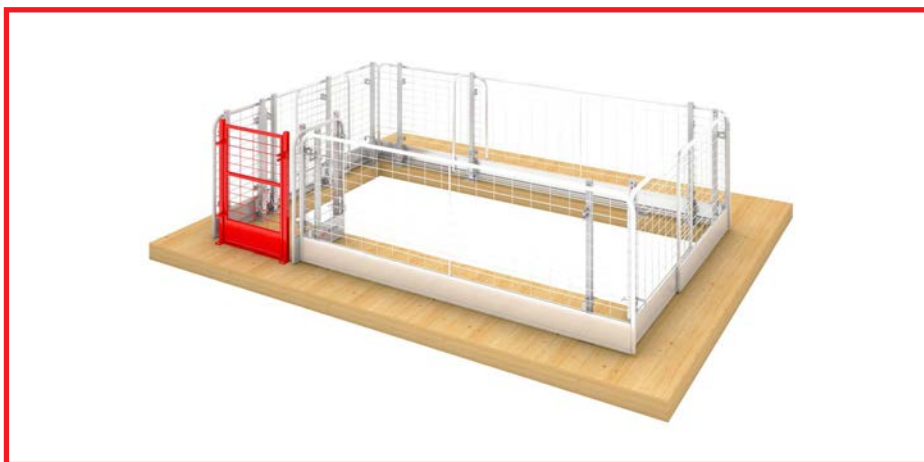



## Technical Service & Support

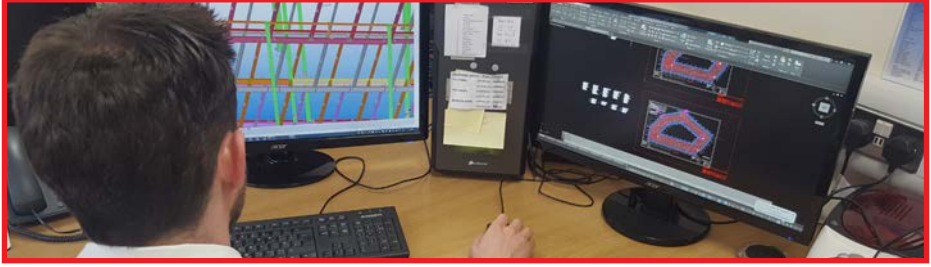

Using the most up to date detailing software available, our dedicated technical advisors are on hand to ensure your project is in safe hands.

### Project Management

Offering expert advice from enquiry stage through to supplying the equipment, the technical team are dedicated to sorting out potential fall prevention problems on the drawing board and not on site.

### Training

In house industrial training is available on request at our manufacturers training centre in Leeds, product training and training covering the standard for Temporary Edge Protection Systems, BS EN 13374 is available to all customers.



# Technical Service & Support

## Step 1 - Assessment

On receipt of drawings, the team will make assessments of the areas to be protected. This process acts as a working brief and ensures any potential problem areas are considered and discussed at the early stage of the enquiry. This assists in making sure the most suitable and efficient solution is supplied.



## Step 2 - Quotation

A quotation will be prepared with the areas to be protected, the general quantity of perimeter edge protection required. This process offers the client the opportunity to question the installation requirements and consider the overall project costs.

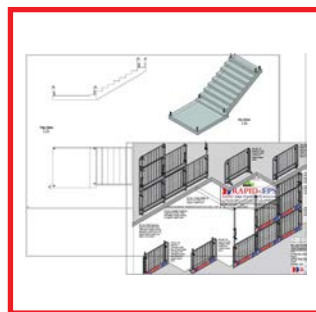

## Step 3 - Detailing

On instruction to proceed, the technical team will produce the detailing requirements and final positioning of the edge protection solutions. Supporting guidance and drawings can be supplied at this stage which will assist the installers with positioning the correct equipment in the correct areas.

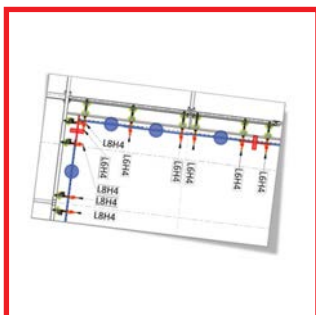

## Step 4 - Supply

On instruction from the client, the deliveries of equipment will be made to site in a phased manner and at a time to suit site activity. This ensures you are getting what you need, when you need it. Project management and site support is on hand from the start of your project until completion.

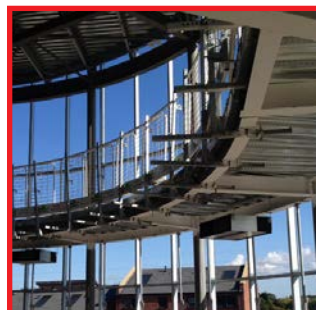



# Combisafe Edge Protection & Fall Protection System



Altrad Generation are a preferred supplier of the Combisafe Edge Protection System, established nearly 40 years ago, their continued development of the product range means they have earned the reputation of delivering a user friendly, adaptable edge protection system. The Combisafe range of components, together with the new lightweight barrier range available in 5 sizes, means we can offer a multitude of solutions to suit a wide range of applications.

All products are fully tested and have been proven to meet and exceed the test requirements set out in BS EN 13374:2013 for Class A and Class B.

## Standard Height Barriers



Lightweight barrier providing guardrail, toeboard and debris mesh in one product.

Code	Description	Size	Weight
074419	Steel Mesh Barrier 0.5	500mm	3.60kg
074418	Steel Mesh Barrier 0.9	900mm	5.70kg
074416	Steel Mesh Barrier 1.5	1500mm	8.70kg
074437	Steel Mesh Barrier 1.8	1800mm	10.00kg
074031	Steel Mesh Barrier 2.6	2600mm	14.20kg

# Combisafe Edge Protection & Fall Protection System

When choosing the Combisafe Edge Protection you can be assured of:

- Dedicated Combisafe trained Account Manager: [combisafe@altradgeneration.com](mailto:combisafe@altradgeneration.com)
- Detailed quote with technical drawings.
- Optional additional detailed drawings, including phasing and indexing to save you time on-site
- On-site product familiarization.
- On-site support, including installation and erection checks.
- Comprehensive installation guides.
- Edge Protection Federation accredited courses available.
- Readily available stock within our network of branches across UK.
- Fast and flexible delivery via our fleet of lorries, fitted with Hiab cranes.



## Make Up Height Barriers

Used together with the steel mesh barrier to increase height of edge protection to 1750mm.

Code	Description	Size	Weight
<b>074420</b>	Steel Mesh Barrier Make-up 1.5	1500mm	4.40kg
<b>074000</b>	Steel Mesh Barrier Make-up 2.6	2600mm	7.00kg



## Universal Safety Posts

When mounted with the various attachments and steel mesh barriers, it forms a safe fall protection solution.

Code	Description	Length	Weight
<b>037102</b>	Safety Post, 1.15m - System C	1150mm	1.90kg
<b>037101</b>	Safety Post, 1.35m - System C	1350mm	2.20kg
<b>037103</b>	Safety Post, 1.80m - System C	1800mm	2.90kg
<b>074417</b>	Steel Quick Release Safety Post 2.2m	2200mm	9.70kg
<b>074450</b>	Steel Quick Release Safety Post 2.5m	2500mm	10.50kg



## Steel Frame Solutions

Their range of attachment's available gives the user multiple solutions for any scenario on site, this together with the adaption process makes it the simplest and most user-friendly system to use on Steel Frame buildings.



### Flexi Attachment MK2 - System C

Used to provide a post attachment at an adjustable offset, up to max 350mm from a vertical surface. Used in beam webs, walls, facades, shaft sides or slab edges etc..

Full Flexi Attachment is an extended version of the Flexi Attachment, offering up to a 650mm range of movement.

The Cantilever Bracket is an extended version of the flexi attachment, protrudes 1000mm from beam. Requires two posts per attachment

Code	Description	Size	Weight
074030	Flexi Attachment MK2 - System C	380mm x 494mm	4.80kg
074431	Full Flexi Attachment	-	6.90kg
074433	Cantilever Bracket	-	17.60kg



### Steel Jaw Clamp MK2 - System C

Ensures a secure attachment to steel beams and columns. The jaws and the sacer can be re-positioned on the body to increase the offset or to attach in both the horizontal and vertical plane.

Code	Description	Size	Weight
074404	Steel Jaw Clamp MK2 - System C	270mm x 850mm	7.90kg

## Steel Frame Solutions



### Welded Socket

Welded directly to steel beams to support edge protection safety posts, used in conjunction with precast attachment sleeves eliminates the risk of accidental removal of the post.

Code	Description	Size	Weight
037115	Welded Socket	-	0.50kg
074415	Intermediate Flange Socket	-	2.50kg

### Pre-cast Attachment Sleeve - System C

For use with welded socket.

Code	Description	Size	Weight
074408	Pre-cast Attachment Sleeve - System C	-	0.10kg



## Concrete Frame Solutions

With a wide range of flexible solutions combining all the benefits of edge protection pre-planning with the versatility of a proven, easy to manage barrier system that saves time and money on-site.



### Timber Beam Attachment MK2

Used to attach beams and proprietary forming systems.

Code	Description	Thickness	Weight
074410	Timber Beam Attachment MK2 - 60 mm	60mm	4.00kg
074411	Timber Beam Attachment MK2 - 40 mm	40mm	3.80kg



### Power Post

Provides easy access to the compression unit hex head, allowing compression to be adjusted as the slab starts to relax. The load indicator is visible through the mesh barrier and for added safety the compression thread is protected by a steel tube.

### Power Post Extension

The Power Post Extension allows the reach of the Power Post to increase from 3.5m to 4.2m.

Code	Description	Size	Weight
074438	Power Post	-	17.00kg
074439	Power Post Extension	-	3.10kg



## Concrete Frame Solutions



### Multifoot - System C

Most commonly used at the slab edge, the three points of support allow accurate installation on an uneven surface.

Code	Description	Size	Weight
037110	Multifoot - System C	-	1.60kg



### Multi Clamp MK2 - System C

Versatile attachment, can clamp vertically or horizontally over a thickness ranging from 20mm up to 620mm using the reversible jaw.

Code	Description	Size	Weight
010071	Multi Clamp MK2 - System C	850mm x 270mm	7.90kg



### Verti Clamp - System C

Clamps to narrow structures from 0-150mm thick, such as steel sheets. The heavy-duty course thread is quick to set and tightened using a hammer.

Code	Description	Size	Weight
074032	Verti Clamp - System C	-	5.10kg



## Concrete Frame Solutions



### Balcony Attachment - System C

Designed to use case in chanels or the fixings for permanent handrails.

Code	Description	Size	Weight
037001	Balcony Attachment - System C	320mm x 179mm	1.60kg



### Stair Attachment - System C

Used to support systems on stairs, permitting access to the top of the stair unit.

Code	Description	Size	Weight
074045	Stair Attachment - System C	-	2.70kg

## Full Height Debris Containment Solutions

A one of its kind full height debris containment net solutions offering fast installation whilst also maintaining the post centres with the use of integrated horizontal bars as part of the net. Thus, vastly reducing the risk of dropping objects from the building.



### Power Post

Provides easy access to the compression unit hex head, allowing compression to be adjusted as the slab starts to relax. The load indicator is visible through the mesh barrier and for added safety the compression thread is protected by a steel tube.

### Power Post Extension

The Power Post Extension allows the reach of the Power Post to increase from 3.5m to 4.2m.

Code	Description	Size	Weight
074438	Power Post	-	17.00kg
074439	Power Post Extension	-	3.10kg



### Power Post - Claw Grip

Used with the Power Post, this hardened steel claw grip provides additional security against slipping when using friction erection.

Code	Description	Size	Weight
074441	Power Post - Claw Grip	-	1.00kg



### Power Post - Foot

Used to secure the Power Post to the floor when a positive mechanical anchor is required.

Code	Description	Size	Weight
074444	Power Post - Foot	-	3.10kg



## Full Height Debris Containment Solutions



### Containment Q20-net Assy

20mm x 20mm mesh, designed to contain debris within the system.

Code	Description	Size	Weight
074440	Containment Q20-net Assy	20mm x 20mm	9.00kg



### Net Tube Holder Coupler

Used to attach nets at any desired height between the floor and the soffit.

Code	Description	Size	Weight
074443	Net Tube Holder Coupler	-	2.20kg



### Containment Reach Hook

For lifting nets into position, the Reach Hook is adjustable in length to enable safe installation without the need to work at height.

Code	Description	Size	Weight
074442	Containment Reach Hook	-	1.30kg

## Staircase Edge Protection

The varied nature of the stairs, landings, and returns, often required many cut tubes, sharp ends, and much purpose-built protection. The Steel Mesh Barrier Stair has been designed to solve these problems, offering a systemised solution to integrate with the Steel Mesh Barrier system.



### SMB Stair

Provides continuous edge protection to a run of stairs - can be raised up using barrier holder to enable works to the edge of the stair

### SMB Gap Closer

Used to fill gap voids and returns between 100mm and 500mm, held in place with four integral straps

Code	Description	Size	Weight
037112	SMB Stair	-	14.00kg
037114	SMB Gap Closer	-	2.40kg



### Stair Attachment

Used to support systems on stairs, permitting access to the top of the stair unit.

Code	Description	Size	Weight
074045	Stair Attachment - System C	-	2.70kg



## Staircase Edge Protection



### Multiclamp Adaptor

Versatile attachment that works in conjunction with Multiclamp to provide clamp on solution to the staircase.

Replacement body for Multiclamp.

Code	Description	Size	Weight
074413	Multiclamp Adaptor 30 degrees - System C	-	1.20Kg
074425	Multiclamp Body Only	-	3.90Kg



### Multifoot

Most commonly used at the slab edge, the three points of support allow accurate installation on an uneven surface.

Code	Description	Size	Weight
037110	Multifoot System C	-	1.60kg



# Notes





# Rhino Load Deck Safety System

Working at height regulations

Fall prevention System

Working at height

Trestle Handrail System

Training Certification

Install and Dismantle Services

Features & Benefits





# Rhino Load Deck Safety System

## Working at Height Regulations

The Working at Height Regulations set out a simple hierarchy for managing and selecting equipment for work at height.

Duty holder must consider the safety of workers and, where work at height cannot be avoided, use equipment that prevents falls. Where fall prevention cannot be used then fall arrest should be used.





# Rhino Load Deck Safety System

## Fall Prevention Solution

The optimum load deck system taking safety to the next level, the Rhino Load Deck System has been fully tested and wholly complies with the following standards:

- Temporary Works Equipment BS EN 12811-1 section 6.1.3 load class 6;- 6.0kN/m<sup>2</sup>, 6.2.2.3 and 6.2.2.4
- Temporary Edge Protection Systems BS EN 13374
- Addresses Health and Safety issues
- Fully self-supportive
- Multi-level working platforms from 0.5m to 4m
- Robust for all building applications
- Fits all irregular floor plans
- Quick and easy to install
- Increases productivity
- Protects stairwells

Safe Working Load of Platform System:

600kg/m<sup>2</sup> at a maximum height of 3m

300kg/m<sup>2</sup> at a maximum height of 3.5m

150kg/m<sup>2</sup> at a maximum height of 4m





# Rhino Load Deck Safety System

## Working at Height



- This system not only provides a safe working platform, but allows operatives to load the platform with necessary tools and materials for efficient task expediency
- The unique and versatile 3-in-1 fall prevention safety system offers solutions for access, loading and working, both safely and productively, at height
- Completely self-supportive, the Rhino system does not rely on your external or party walls for lateral support



## Trestle Handrail System

- Versatility of design means that Rhino Load Deck can equally form a trestle system.
- Ability to add to a trestle and handrail to develop a full load deck system, as needs dictate.
- Rhino provides both a versatile working platform together with the option of a handrail.

**Safe Working Load  
of Trestle System:  
600kg/m<sup>2</sup>**

**at a maximum height of 2m  
Refer to Altrad Generation for  
heights over 2m**



# Rhino Load Deck Safety System



## Training Certification

- Product familiarisation to all of your employees
- Toolbox talks with practical workshops
- Full installation training with up to six delegates per day certificated on completion
- Formal training with qualification available



**FASET**  
Fall Arrest Safety Equipment Training



## Install and Dismantle Service

- The Rhino Load Deck Install and Dismantle Service offers site managers an all-encompassing hire, installation and dismantle option
- Install Services use a highly-skilled and experienced team, thereby reducing man hours and completion times
- Increases productivity and efficiency
- Installers also adhere to all current Health and Safety Rules
- Full site survey and design service available as well as transport and expert on-site assembly



**For more information on this service, please contact [rhino.enquiries@altradgeneration.com](mailto:rhino.enquiries@altradgeneration.com)**





# Rhino Load Deck Safety System

## Features and Benefits

- The safety platform system offering an optimum solution for working at height
- Can be used as a wall to wall safety platform or as a trestle and handrail system
- Rhino Load Deck provides unrivalled versatility, ease of use, strength and durability
- With fast installation and multi trade use, brickwork, roofing, plastering, the system offers a unique cost-effective solution
- The system not only provides a safe working platform but allows operatives to load the platform with necessary tools and materials



### Lightweight:

- Rhino Load Deck panels are less than 9kgs each
- Unique use of materials minimises the weight needed to achieve its strength and durability
- The lightweight components and ease of assembly means that there is a reduced risk of injury during installation



### Built for Ease of Access:

- 1.3m spacing between legs ensures space for a pallet truck
- Leg braces are only used in the corners keeping access areas clear and open
- Panels can be removed to give deck access from below without impacting on structural integrity



### Strong and Durable:

- Can support loads rated at up to 600kg per square metre at a 3m platform height
- Does not require standing walls for support
- Can be raised in height by building onto the legs and raising the framework and deck panels
- Unaffected by weather extremes



# Rhino Load Deck Safety System

## Features and Benefits

- Components lock into place without the need for hand tools or fixings
- Fast and easy-to-install method allows safer working at heights of up to 4m
- Up to ten times faster to install than traditional scaffolding
- Needs minimal site space for storage and it is easy to transport from site to site



## Rhino Load Deck Components



### Fasty Strap

Used to secure the make-up panel.

Code	Width	Depth	Length	Weight
062223	25mm	-	450mm	0.02kg



### R Clips & Pins

Clips and pins are used to secure the feet into the legs.

Code	Width	Depth	Length	Weight
062244	8mm	8mm	50mm	0.03kg



# Rhino Load Deck Components



## Leg Base Plate

Standard Base plate for use with the Rhino Deck Trestle and Handrail system as well as the Load and Workdeck system.

Code	Width	Depth	Length	Weight
<b>062219</b>	125mm	125mm	150mm	0.39kg



## Cross Brace 400 / 640 / 1280mm

Cross braces of varying lengths to fit the Rhino Deck Trestle and handrail system as well as the load and Workdeck system.

Code	Width	Depth	Length	Weight
<b>062203</b>	40mm	135mm	400mm	0.84kg
<b>062202</b>	40mm	135mm	640mm	1.26kg
<b>062201</b>	40mm	135mm	1280mm	2.34kg



## Cross Brace 640mm - Extendable Swivel Ends

Cross brace which is adjustable from 640mm - 1280 mm with swivel ends to accommodate corners and infill panels.

Code	Width	Depth	Length	Weight
<b>062259</b>	40mm	135mm	640mm	3.01kg



## Leg Brace 1000 / 1500 / 2000 mm

Standard Leg Brace to ensure rigidity, for use with Rhino Workdeck system.

Code	Width	Depth	Length	Weight
<b>062205</b>	120mm	70mm	1380mm	1.14kg
<b>062220</b>	120mm	70mm	1600mm	1.06kg
<b>062221</b>	110mm	80mm	1930mm	0.88kg

**062221** - For use with both Leg 1800 and Leg 2000.



# Rhino Load Deck Components



## Leg 500 / 1000 / 1500 / 1800 / 2000 mm

Standard Leg for use with Rhino Workdeck system.

Code	Width	Depth	Length	Weight
<b>062216</b>	125mm	125mm	500mm	1.25kg
<b>062200</b>	125mm	125mm	1000mm	2.11kg
<b>062217</b>	125mm	125mm	1500mm	3.08kg
<b>062237</b>	125mm	125mm	1800mm	3.66kg
<b>062218</b>	125mm	125mm	2000mm	5.02kg



## Leg 1800mm - Fixed Base

Complete leg assembly for use with Rhino Workdeck system.

Code	Width	Depth	Length	Weight
<b>062241</b>	125mm	125mm	1800mm	3.80kg



## Leg 2000mm - Trestle Leg

2000mm trestle leg - a standard component for handrail systems.

Code	Width	Depth	Length	Weight
<b>062245</b>	125mm	125mm	2000mm	5.06kg



## Hand Rail Post

Inserted into the top of a leg to provide the fixing brackets for hand rails.

Code	Width	Depth	Length	Weight
<b>062211</b>	125mm	125mm	1200mm	2.75kg



# Rhino Load Deck Components



## Standard Deck Panels 400 / 640

Deck panels are available as both 1280 x 400 and 1280 x 640 to enable easy configuration of the Rhino Deck system.

Code	Width	Depth	Length	Weight
<b>062209</b>	380mm	80mm	1300mm	5.82kg
<b>062207</b>	640mm	80mm	1300mm	9.40kg



## Heavy Duty Deck Panels 400 / 640

Heavy Duty Panel 1280 x 400 and 1280 x 640 for use with Rhino Load Deck and Trestle System.

Code	Width	Depth	Length	Weight
<b>062270</b>	380mm	80mm	1300mm	6.70kg
<b>062268</b>	640mm	80mm	1300mm	11.00kg



## Guard Rail Gate

Allows access to exposed edge where a handrail is in use.

Code	Width	Depth	Length	Weight
<b>062228</b>	800mm	80mm	640mm	3.02kg



## Make Up Panel

For use with Fasty Straps to cover over irregular areas in the decking configuration. Yellow in colour to draw attention to the fact that they are slightly raised.

Code	Width	Depth	Length	Weight
<b>062215</b>	640mm	12mm	800mm	4.25kg



## Rhino Load Deck Components



### Timber Kick Board 400 / 640 / 1280 mm

Timber kickboard to prevent materials and tools dropping over the edge of a Rhino Deck structure. They match the sizes of the decking panels.

Code	Width	Depth	Length	Weight
<b>062246</b>	150mm	12mm	400mm	1.04kg
<b>062247</b>	150mm	12mm	640mm	1.25kg
<b>062248</b>	150mm	12mm	1280mm	1.53kg



### Ladder Bracket

To fit on the side of any Rhino Deck structure to allow for the safe use of a ladder.

Code	Width	Depth	Length	Weight
<b>062236</b>	500mm	80mm	500mm	2.56kg

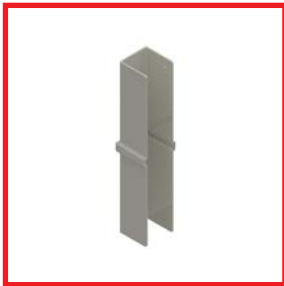

### Leg Joining Support

The leg joining support enables extension of the standard leg to take a handrail system.

Code	Width	Depth	Length	Weight
<b>062214</b>	38mm	38mm	380mm	0.39kg



# Ladders & Builders Products

Scaffold Ladders  
Ladder Safety Products  
Adjustable Steel Props  
Trestle Handrail System  
Strongboy® Masonry Wall Supports



## Scaffold Ladders



### Tuffsteel Ladders

Certified to BS EN131 and tested to Class 1 strength criteria. With aluminium zinc for maximum corrosion resistance which improves overall finish, prevents chipping and flaking of the paint and protects from inner corrosion. Kitemark Licence No. KM34154.



Code	Description	Length	Weight
309011	Tuffsteel Ladder 3.0m	3000mm	10.00kg
309012	Tuffsteel Ladder 3.5m	3500mm	11.00kg
309013	Tuffsteel Ladder 4.0m	4000mm	18.00kg
309014	Tuffsteel Ladder 5.0m	5000mm	23.00kg
309015	Tuffsteel Ladder 6.0m	6000mm	28.00kg
309016	Tuffsteel Ladder 7.0m	7000mm	32.00kg
309017	Tuffsteel Ladder 8.0m	8000mm	37.00kg

### Heavy Duty Timber Ladders

Scandinavian white wood stiles tapered, with selected hardwood rungs at 250mm (10") centres. Finished with two coats of ladder preservative. Half sized ladders also available.



Code	Description	Length	Weight
308047	Timber Ladder 3.0m	3000mm	10.00kg
308019	Timber Ladder 4.0m	4000mm	14.00kg
308011	Timber Ladder 5.0m	5000mm	18.00kg
308012	Timber Ladder 6.0m	6000mm	22.00kg
308020	Timber Ladder 7.0m	7000mm	26.00kg
309017	Timber Ladder 8.0m	8000mm	30.00kg
308039	Timber Ladder 9.0m	9000mm	34.00kg
308037	Timber Ladder 10.0m	10000mm	38.00kg

## Ladder Safety Products



### Ladderguard

The ideal deterrent to the unauthorised use of site ladders. Made from 2.5mm aluminium sheet the Ladderguard is 1140mm long by 250mm wide and comes complete with warning sticker attached. Ladderguard quickly locks in position on the ladder, using padlock supplied.

Code	Dimensions	Weight
047500	H: 1140mm W: 250mm	5.00kg



### Ladder Access Trapdoor

The Ladder access trapdoor hinges over ladder scaffold apertures preventing falls from exposed openings. BSEN 12811

Code	Dimensions	Weight
048063	H: 585mm W: 710mm	8.00kg

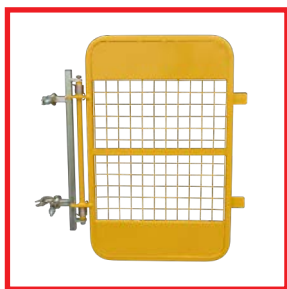

### Reversible Handrail Safety Gate

Altrad Generation's Reversible Handrail Safety Gate is made to hang from either the left or right side with integral toeboard protection. The gate comes fully electroplated before being powder-coated for high visibility and spring loaded for added safety and efficiency.

Code	Dimensions	Weight
048061	H: 1020mm W: 570mm	9.00kg



### Ladder Clamps

Developed for the safe and secure fitting of all ladder types from steel, timber or aluminium ladders to scaffolding.

Very quick and easy to use with no special tools required as the device can be tightened securely using a standard scaffold spanner.

Code	Dimensions	Weight
045039	-	0.44kg

# Steel Props

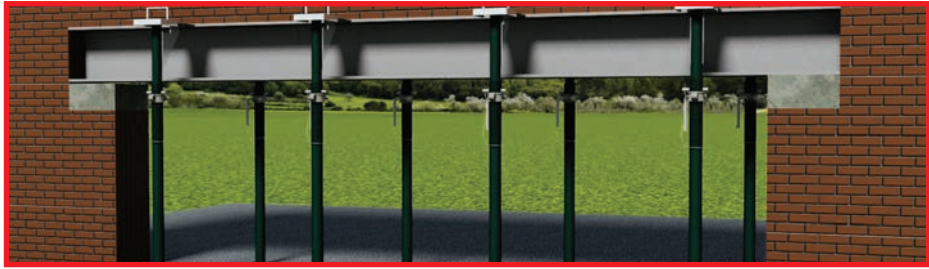

## Adjustable Steel Props

Manufactured to BS4074:1982 and tested to BS5507-3:1982, Altrad Generation's Adjustable Steel Props are designed to support a range of formwork and falsework applications, floors, ceilings, openings and temporary beams.

Outer tube: 60.3mm Dia / Inner tube of 48.3mm Diameter.  
Head and Base Plates: 150x150x6mm to BS4360 with 38mm Dia. hole.

Code	Size	Height	Weight
405050	0	1.04m - 1.83m	12.95kg
405051	1	1.75m - 3.13m	18.64kg
405052	2	1.98m - 3.35m	19.55kg
405053	3	2.59m - 3.96m	22.57kg
405054	4	3.20m - 4.88m	26.36kg



## Adjustable Steel Push-Pull Props

Adjustable Steel Push-Pull Props are designed for holding and plumbing single and double faced forms. The lower plate is fixed to a ground anchor with the top plate being fixed to the shutter. The Adjustable Push-Pull Prop includes a standard Prop Collar with an additional Locking Collar to maintain rigidity as well as maximum safety. Head and Base Plates - 150 x 150 x 6mm to BS4360 with 38mm Dia. hole.

Fully compliant to BS4074 and tested to BS5507.

Code	Size	Height	Weight
405103	0	1.140m - 1.829m	10.90kg
405104	1	1.850m - 3.124m	19.30kg
405105	2	2.080m - 3.352m	20.20kg
405106	3	2.690m - 3.962m	22.80kg
405107	4	3.300m - 4.876m	27.50kg



## Trestle Handrail Systems



The 3.9m Trestle Handrail System is a simple and easy to erect system used in conjunction with adjustable steel trestles which has been specially developed to meet the needs of the Working at Height Regulations. Using only four components a full hand rail, complete with brick guard, toeboard and stabilisation can be erected in minutes.

### Features and Benefits

- Tested and conforms to BS EN 13374 edge protection
- Provides full class 'A' protection
- Fits 2 and 3 sizes of builders trestles. 4 trestles needed per 3.9m Trestle Handrail System
- Can be safely assembled from the ground by just one man
- No 'systemised' spacing bars or fixed width handrails
- Integral stabilisation, brickguards and toe boards



Code	Description	Weight
359005	Handrail Post	7.00kg
359006	Handrail Panel	9.00kg
359007	Stabiliser	1.50kg
359008	Ladder Post	7.00kg



### Adjustable Steel Trestles

- Lightweight steel design
- Powder coated finish
- Quality tested to BS1139
- Safe Working Load 4.7kN (470kg) UDL

Code	Description	Weight
359004	Trestle Size 1 0.51m - 0.71m	7.00kg
359003	Trestle Size 2 0.76m - 1.17m	9.00kg
359001	Trestle Size 3 1.07m - 1.68m	1.50kg

## Masonry Wall Supports (Strong Boy®)



The Masonry Wall Support is used as an adaption to an Adjustable Steel Prop, conforming to BS4074:1982, to provide support to brickwork and other construction support structures.

Due to the Masonry Wall Supports robust dynamics, it can be fitted between courses on a double-skin, brick cavity wall from either side. Therefore providing a cost effective, efficient and safe construction component. The Masonry Wall Support is zinc plated, this ensures a long life and low maintenance product.

Code	Product	Weight
407800	Strongboy®	5.80kg



Strongboy XL supports walls with a thickness up to 300mm and fitted with a new patented plate locking bar for a safer, more secure, operation.

- Supports walls up to 300mm thick when installing lintels
- Blade into mortar joint to provide support while you work
- Used in conjunction with an adjustable steel prop
- Support every 900mm
- SWL 340kg

Code	Product	Weight
407802	Strongboy® XL	7.00kg

# Notes

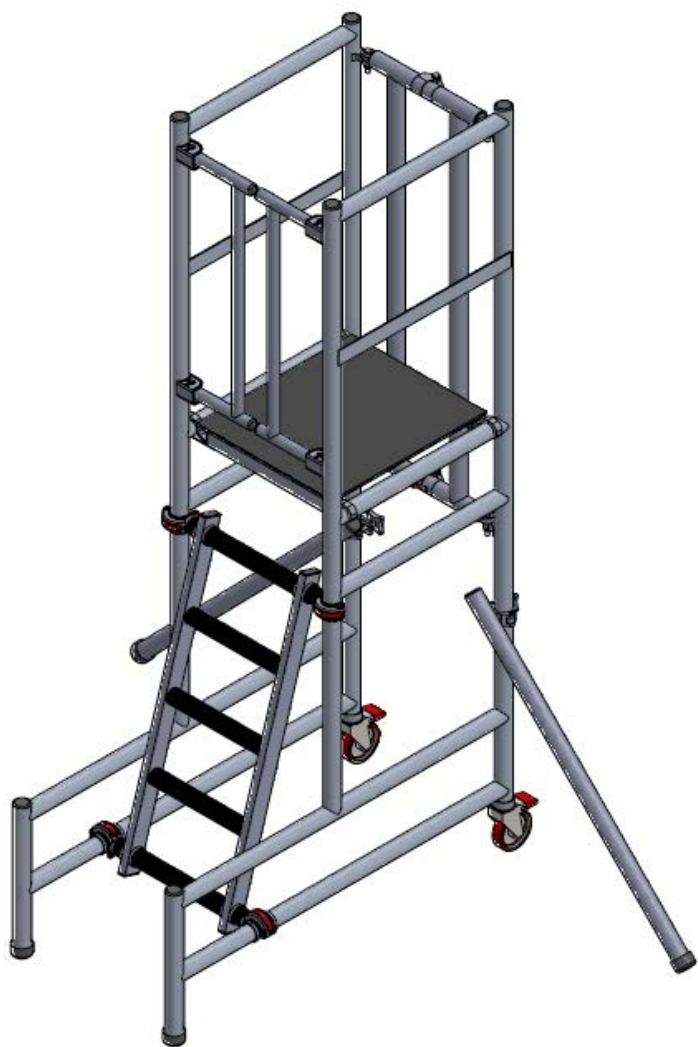

# Specialist Light Access

Specialist Modular Alloy Systems

Light Access Accessories

Betaguard® Advanced Guardrail

MAST 250 Alloy Span Tower

MAST Low Level Folding Platforms

BoSS Aluminium Span Tower

BoSS GRP Zone 1 Tower

BoSS Ladderspan and Clima Tower

Low Level Access Platforms

Stagings

Aluminium Access

Spandek Walkway System





## Specialist Modular Aluminium Solutions



From its specialist branch in London, Altrad Generation Access provides solutions for all access requirements with a full range of modular tower systems.

**From a simple tower to a complex structure Altrad Generation Access supply both material and expertise to the construction and industrial sectors. Equipment is supplied for hire and sale or alternatively with a full erection service undertaking complex structures and demanding solutions to all access problems.**

Towers can be supplied in a vast range of configurations and heights to suit all trades. Large deck areas and low level access systems provide safe access to soffit applications. Cantilevers and facade structures provide solutions to the most difficult access areas.



Our branch in West Thurrock (London East) provides a fast response service to all access problems. A full range of MAST Aluminium Span Towers, Boss Ladderspan, Glass Reinforced Plastic, and Evolution Towers are available, plus Folding Room Scaffolds, Podiums, Stagings, and Low Level Platforms.

Altrad Generation specialise in the supply of 250mm rung frames for maximum flexibility at working height. Staff are trained to Advanced PASMA standard, and Manufacturer specific trained and all hold CSCS card registration.

Free Site Surveys

## Light Access Accessories



### Cantilever Towers

Cantilever towers are useful when needing to protrude outside the normal base dimensions. Difficult areas such as riser shafts or window apertures can be overcome.



### Fold Easy Towers

Small and lightweight, with no braces just a folding frame. Useful for corridors and small rooms and able to pass through a standard doorway without dismantling.



### Rail Maintenance Towers

Towers that can be used on railway tracks via special 'bogies' that sit on the rail. They can be raised and lowered for high level work.



### Gladtag for Towers

Generation's Alloy Tower Inserts helps companies to comply with current legislative requirements ensuring employees are informed if equipment is not safe to use. Supplied in boxes of 10 with 20 inserts and 2 pens.

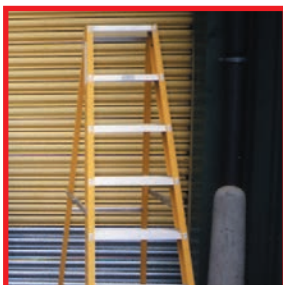

### Ladders and Steps

An extensive range of steps and ladders are available including aluminium and fibreglass to cover all trades.





## Light Access Accessories



### Site Safe

Designed to deter the most determined thief, a strong sturdy steel storage container for expensive tools and equipment on site, or in your workshop.



### No-Nocs

No-Nocs are designed to reduce impact and scuffing damage to finished surfaces. Compatible with a range of equipment, including low-level access, aluminium towers and system scaffold.



### Podium Steps

Podium steps are the safe alternative to builders steps and weigh less than 22kg. When assembled it will go through a standard doorway.



## Betaguard® Advanced Guardrail System



Assembly and dismantling aluminium towers must comply with the standards set out by the Work at Height Regulations.



Hierarchical requirements place collective protection over mitigation options. As an advance guardrail system the BetaGuard® provides best practice collective protection, but without the manual handling problems currently associated with industry practice.

The BetaGuard® simplifies tower erection by eliminating the need for both horizontal and diagonal braces, reducing the main components to a total of three.

Structural safety is also improved with the bracing integrated into the BetaGuard® frame. Utilisation and asset management is achieved with ease as individual single bracing members more susceptible to loss, damage and theft are replaced.

Other benefits of the Betaguard® Advanced Guardrail System include its ability to act as a bridging components to bridge towers, removing the need for bridging lattice beams. Tower erection without trip hazards at base level and a walk in/through facility with high clearance is automatically achieved.

Code	Description	Platform Heights	Bay Sizes	Widths
<b>106017</b>	1.5m Betaguard	1.2m to 12.2m	1.5m	0.85m
<b>106018</b>	2.5m Betaguard	1.7m to 11.7m	2.5m	1.45m



## MAST 250 Aluminium Span Tower



The MAST 250 Tower System offers simplicity and safety combined with an increased strength and versatility that ensures regular use across various industry applications.

Fully compliant with HD1004 and ISO9002 accreditation the MAST 250 Tower System is available in both Span (1.45m wide) and Narrow Width (0.85m wide) options. With each option available in three platform lengths (1.5m, 2.5m and 3.2m) there is a tower available for every application.

The MAST 250 has been specifically designed to create handrails at the correct levels in difficult access areas. Selected MAST 250 frames are available in 250mm increments to meet all height requirements particularly in restricted and under soffit applications. 250mm rung flexibility ensures maximum handrail safety to the working platform.



**Betaguard Advanced  
Guardrail Available**

### Safe

Guaranteed guardrail positioning at any chosen platform level.  
Safe access to the working platform - every time!  
Connecting frame to frame is safer and quicker with the conical head spigot.  
Non-slip deck provides a safe, highly durable work area.  
All frame rungs have a non-slip serrated finish.

### Fast

Easy to erect and dismantle.  
Fully climbable frames, no need for clip-on ladders or ladder frames.  
All components locate quickly without unnecessary clips and pins.

### Easy

Various add-on components available allowing the MAST 250 to be adapted to suit more specialised needs.  
Greater choice in platform heights providing pin point access to the work area.



## MAST Low Level Folding Platforms

Altrad Generation's MAST folding work platform is designed exclusively for low level access and is erected with ease to form a safe and simple work platform.

The MAST folding work platforms assemble and dismantle in seconds with only two components required. It's compact dimensions allowing for easy storage and transportation.

### Features and Benefits

- Automatic folding frames, with no pins or clips.
- Compact dimensions allow the MAST folding work platform to be moved from room to room while still assembled.
- 6 rung frame for more choice in working heights.
- Spigot free frames eliminate improper use.
- Designed exclusively for low level access.
- Unique guardrail system also available, offering a fully protected working platform at all times.
- Serrated, non slip rungs (at 250mm centres) and trapdoor platform for safe access to the working area as standard.
- Weather proof, anti-skid decking for a safe working area.
- Equipped with 4 lockable castors.
- Compatible with existing MAST aluminium tower components.
- Folding one piece toeboards available.
- Overall H x W x D: 2600 x 1500 x 730mm.
- Weight 55.17kg.





## BoSS Aluminium Span Tower



The BoSS Aluminium Tower System is designed to meet users requirements and can be assembled in many different ways to provide safe working platforms for construction industry or inspection/maintenance purposes.

Four basic tower configurations are available 850mm and 1450mm ladder span, stairway and the folding room scaffold. A range of component for special applications such as cantilevers, facade scaffolding systems, bridge structures and pedestrian access are also available.



### Features and Benefits

- 1.8m, 2.5m and 3.2m fixed and trapdoor decks available
- Deck width 600mm
- 275kg distributed load capacity
- Solid aluminium deck claw is 40mm wide preventing damage to frame horizontals
- Offset claws on all decks allow continuous runs
- Extruded aluminium deck frame affords total edge protection to combiboard deck minimising damage
- Large trapdoor (662mm x 531mm) for easy access to platforms



Deck Claw



Toeboard Clip



Castor



All braces are colour coded for ease of use.

## BoSS GRP Zone 1 Tower



GRP Zone 1 Tower is specifically designed to be used where the use of Aluminium Towers are not appropriate. Providing a safe, non conductive, clean and efficient full protection tower system.

### Zone 1 Areas

The Zone 1 areas are areas in which an explosive atmosphere is likely to occur in normal operation. In these areas only Zone 1 rated materials are ACCEPTABLE and where the use of GRP is highly recommended. The Zone 1 Tower is made up from Glass Reinforced Plastic (GRP). It won't spark, oxidise, conduct electricity or corrode, it combines strength, durability and ease of use.

### Conductive

The Zone 1 Tower is non conductive, making it safe to use around electrical installation for repair, inspection and maintenance work. It is particularly appropriate for use in electrical engineering applications and in the rail industry.



### Non-Sparking

Static electricity represents a real hazard in many industrial applications. Zone 1 Tower will not 'spark' and is therefore safe to use in areas where dust, vapour or other combustible material is present.

### Non-Corrosive

GRP is a tough, non corrosive material that is resistant to electrolytic corrosion caused by salt water, deterioration caused by caustic chemicals and damage arising by contact with gasoline, oils, lacquers and most solvents commonly found on industrial sites.

### Non-Oxidising

Unlike aluminium, GRP does not oxidise and so keeps works surfaces clean and residue free. This is essential in food manufacture, food preparation areas and in applications that are 'clean' or hygiene sensitive.





## BoSS Ladderspan & Clima Tower



### BoSS Ladderspan Tower

This exceptional aluminium access tower offers all the features of original BoSS and many more besides.

#### Features and Benefits

- Increased rigidity
- Fully compliant with original BoSS because all the components are the same with the exception of the frames which are fully interchangeable
- Integral ladders with 250mm rung spacing
- Frame horizontals have a 500mm spacing and ribbed tubing for increased grip
- Two frame widths: 850mm and 1450mm
- 2 deck lengths: 1.8m and 2.5m
- Safe working load of 275kg per platform level up to a maximum of 950kg per tower (including self weight)



### BoSS Clima Tower

Premium lightweight industrial aluminium modular access tower system featuring a climbing frame.

#### Features and Benefits

- Apart from the end frames the system is fully interchangeable with BoSS Ladderspan tower components
- 250mm easy climb frame rung spacing
- Two widths - 850mm Single Width and 1450mm Double Width.
- 3 slip resistant platforms - 1.8, 2.5 and 3.2m with self closing trapdoors and windlocks.
- The maximum platform safe working load is 275kg
- Primed brace identification: Red: horizontal. Blue: Diagonal
- Horizontal braces used as guardrails
- Castors with compact trail/no trail positive locking brace mechanism

### Standard Towers for Stairs

2.8m / 4.3m / 5.8m & 7.3m Platforms

## Low Level Access Platforms



### Delta Deck

The Delta Deck low-level access platform is a complete unit that assembles and dismantles in seconds allowing easy transportation and storage. With 5 working heights it is ideal for those needing flexibility when working at 3m and below.

#### Safe Access

- One person operation
- Fully guardrailed to ensure user safety
- Compact dimensions
- East transportation and storage



### MAST Low Level

The Altrad Generation MAST folding work platform is designed exclusively for low level access and is erected with ease to form a safe and simple work platform. Assemble and dismantle in seconds with only two components required.

#### Safe Access

- Automatic folding frames, with no pins or clips
- Compact dimensions allow for fully assembled movement
- 6 rung frame for more choice in working heights
- Spigot free frames eliminate improper use
- Designed exclusively for low level access
- Unique guardrail system also available
- Serrated, non-slip rungs (at 250mm centres) and trapdoor platform for safe access to the working area as standard
- Weather proof, anti-skid decking for a safe working area
- Equipped with 4 lockable castors
- Compatible with existing MAST Aluminium Tower



## Stagings



### Aluminium Stagings

Purpose designed stagings to provide strong and stable platform for use in scaffolding applications. Standard lengths from 2.4m to 7.2m. Aluminium box section stiles and cross bearers. Combi-board decking, and rubber inserts to underside, to prevent movement. BS2037 certified: Supports 270kg distributed load.



Length	450mm Wide		600mm Wide	
	Code	Weight	Code	Weight
2.5m (8'00")	<b>308200</b>	13.00kg	<b>307006</b>	14.00kg
3.0m (10'0")	<b>308201</b>	15.00kg	<b>307007</b>	16.00kg
3.6m (12'0")	<b>308202</b>	17.00kg	<b>307005</b>	18.00kg
4.2m (14'0")	<b>308203</b>	21.00kg	<b>307001</b>	23.00kg
4.8m (16'0")	<b>308204</b>	28.00kg	<b>307002</b>	30.00kg
5.4m (18'0")	<b>308205</b>	30.00kg	<b>307004</b>	32.00kg
6.0m (20'0")	<b>308206</b>	34.00kg	<b>307003</b>	36.00kg
6.6m (22'0")	<b>308209</b>	40.00kg	<b>307008</b>	43.00kg
7.2m (24'0")	<b>308208</b>	43.00kg	<b>307009</b>	46.00kg



### Handrail Brackets

These Hand Rail Brackets have been designed for use with 450mm or 600mm stagings using just tubular alloy brackets, the handrail securely clamps onto stagings.

Fittings are adjustable to allow use of scaffold boards for toe boards and scaffold tube for handrails.

Code	Dimensions	Weight
<b>308045</b>	450mm Handrail Bracket	3.80kg
<b>307045</b>	600mm Handrail Bracket	4.00kg



### Universal Handrail Brackets

Fits all sizes of LFI stagings, ANY width and ANY length.

Fitted with lock-jaw clamps to provide quick, strong fitting.

Adjustable fittings included to allow for various sizes of tube including standard scaffolding Toe-board clip to accommodate various sizes of board including standard scaffold plank.

Code	Dimensions	Weight
<b>309413</b>	H: 1140mm W: 250mm	5.00kg



## Aluminium Step Access



### Swing Back Steps

Meets BS EN 131-1:2015+A1:2019, BS EN 131-2:2010+A2:2017 & BS EN 131-3:2018

Tested to a gruelling 50,000 cycle "Climbing" durability test

Meets all strength requirements of BS2037 Class 1

Rated to a maximum load and duty rating of 150kgs.

Code	Product	Weight
308245	Aluminium Steps-Swingback 4 tread	4.10kg
308246	Aluminium Steps-Swingback 5 tread	5.10kg
308247	Aluminium Steps-Swingback 6 tread	6.10kg
308248	Aluminium Steps-Swingback 7 tread	7.10kg
308249	Aluminium Steps-Swingback 8 tread	8.10kg
308244	Aluminium Steps-Swingback 10 tread	10.10kg
308259	Aluminium Steps-Swingback 12 tread	12.10kg



### Aluminium Platform Steps

Meets BS EN 131-1:2015+A1:2019, BS EN 131-2:2010+A2:2017 & BS EN 131-3:2018

Tested to a gruelling 50,000 cycle "Climbing" durability test

Meets all strength requirements of BS2037 Class 1

Rated to a maximum load and duty rating of 150kgs.

Code	Product	Weight
123269	Aluminium Platform Steps 3 tread	6.50kg
123262	Aluminium Platform Steps 4 tread	7.30kg
123271	Aluminium Platform Steps 5 tread	8.20kg
123272	Aluminium Platform Steps 6 tread	9.10kg
123275	Aluminium Platform Steps 7 tread	10.00kg
123276	Aluminium Platform Steps 8 tread	10.90kg
123291	Aluminium Platform Steps 10 tread	12.70kg



# Aluminium Ladder Access



## Aluminium Extension Ladders

Meets new improved strength & slip-tests in BS EN131-2:2010+A2:2017

Stress tested by BSI to 20% higher loads than EN131 requires to give Class 1 durability.\*

Stabiliser comes as standard on all ladders that extend beyond 3m for maximum safety.

Rungs orientated flat when erect at correct climbing angle to give a stable standing surface

## Alu Extension Ladders - H7 Range

Code	Product	Weight
308714	Pro Aluminium Extension Ladder 2 Part - 2.0m	9.80kg
308715	Pro Aluminium Extension Ladder 2 Part - 2.5m	10.50kg
308716	Pro Aluminium Extension Ladder 2 Part - 3.0m	12.30kg
308717	Pro Aluminium Extension Ladder 2 Part - 3.5m	14.30kg
308718	Pro Aluminium Extension Ladder 2 Part - 4.0m	18.80kg
308719	Pro Aluminium Extension Ladder 2 Part - 4.5m	22.50kg
308720	Pro Aluminium Extension Ladder 2 Part - 5.0m	24.80kg
308721	Pro Aluminium Extension Ladder 2 Part - 5.5m	30.00kg
308722	Pro Aluminium Extension Ladder 3 Part - 2.0m	15.00kg
308723	Pro Aluminium Extension Ladder 3 Part - 2.5m	17.40kg
308724	Pro Aluminium Extension Ladder 3 Part - 3.0m	21.00kg
308725	Pro Aluminium Extension Ladder 3 Part - 3.5m	26.70kg
308726	Pro Aluminium Extension Ladder 3 Part - 4.0m	34.00kg

## Alu Extension Ladders - H9 Range \*

Code	Product	Weight
308727	HD Aluminium Extension Ladder 2 Part - 2.5m	12.00kg
308728	HD Aluminium Extension Ladder 2 Part - 3.0m	15.50kg
308729	HD Aluminium Extension Ladder 2 Part - 3.5m	18.00kg
308730	HD Aluminium Extension Ladder 2 Part - 4.0m	23.70kg
308731	HD Aluminium Extension Ladder 2 Part - 4.5m	28.90kg
308732	HD Aluminium Extension Ladder 2 Part - 5.0m	31.90kg
308733	HD Aluminium Extension Ladder 2 Part - 5.5m	34.70kg
308734	HD Aluminium Extension Ladder 3 Part - 2.0m	18.30kg
308735	HD Aluminium Extension Ladder 3 Part - 2.5m	23.40kg
308736	HD Aluminium Extension Ladder 3 Part - 3.0m	27.50kg
308737	HD Aluminium Extension Ladder 3 Part - 3.5m	34.60kg
308689	HD Aluminium Extension Ladder 3 Part - 4.0m	39.30kg

# Spandeck Walkway Systems



Altrad Generation Spandeck is a lightweight aluminium walkway bridge, work platform and staging system in one versatile unit for indoor and outdoor locations.

High strength aluminium alloy construction ensures that Spandeck is lightweight and maintenance free whilst integral toe-boards enable it to be used safely as a walkway. Guardrail posts and guardrails are fitted to provide a safe working environment. Before using the below Safe Working Load's, check that the support structure can safely carry these loads.

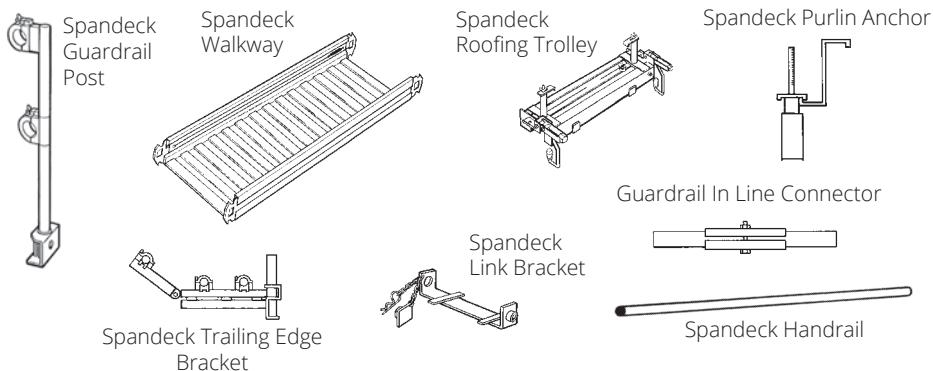

Code	Description	Deck (L)	Width	Weight	SWL
307515	12' Spandeck Walkway	3.7m(12')	600mm	30.00kg	900kg Distributed
307516	16' Spandeck Walkway	5.0m(16')	600mm	39.00kg	675kg Distributed
307526	18' Spandeck Walkway	5.5m(18')	600mm	43.00kg	600kg Distributed
307520	20' Spandeck Walkway	6.1m(20')	600mm	47.00kg	640kg Distributed
307524	24' Spandeck Walkway	7.3m(24')	600mm	55.00kg	450kg Distributed
307500	Handrail	-	-	5.00kg	-
307510	Guardrail	-	-	5.00kg	-
307511	Link Bracket	-	-	5.00kg	-
307512	Purlin Anchor	-	-	2.00kg	-
307513	Roofing Trolley	-	-	8.60kg	-
307514	Trailing Edge Bracket	-	-	7.00kg	-

Code	Description - Sale Only	Deck (L)	Width	Weight	SWL
307612	12' Horizontal Safety Line	-	-	2.00kg	-
307616	16' Horizontal Safety Line	-	-	2.50kg	-
307620	20' Horizontal Safety Line	-	-	3.00kg	-
307624	24' Horizontal Safety Line	-	-	3.50kg	-





# Altrad Generation Export

Generation's Export Division is a leading exporter of scaffold and access - It provides a full service supplying quality British Standard, compliant scaffolding equipment. From the largest available UK inventory of scaffolding and access products.

- Scaffolding, access and temporary roof solutions
- From a few parts to complete project equipment
- Global Scaffolding Supply - Shipping Worldwide
- Quality products that meet or exceed standards
- All industries supported; Construction, Oil, Gas, LNG, Offshore, FPSO, Petrochemical, Civil Projects, Utilities, Energy, Ship Building, Mining, Marine, Events and more.

**"The single source for scaffolding  
equipment globally"**





# Altrad Generation Export



## Stock & Experience

Altrad Generation supply a vast range of Access and Building products across the UK and worldwide; with many years' experience in supplying the international oil, gas, petrochemical, construction and other industries.

From scaffolding ancillaries to full shipping containers of scaffolding, our export division provides a competitive supply from a single source; meeting and exceeding customer expectations.

### Generation can provide you with a complete Export service including:

- A dedicated team of specialists, skilled in the specific requirements of international trade
- Certificates of Conformity and Origin
- Small to large order volumes with quick lead times
- Road, sea and air door to door freight;
- Export documentation





# Altrad Generation Export



## Freight

Road, Sea and Air Freight Services.

World Wide delivery - Incoterms 2020

Full container load (FCL) and Less Container Load (LCL) Services

Consular Documents

Commercial Invoices and Packing Lists

Scheduled Consolidations

## Documentation

When exporting Altrad Generation's products, customers often require supporting and commercial documentation to ensure the on-time delivery of goods.

Altrad Generation Export can advise on and issue the documents you need:

- Cargo Insurance
- EUR1 Movement Certificate
- Certificates of Origin
- Full consular documents certified and legalised
- Bills of Lading - Sea
- CMR - Road
- Airway Bills - Air
- Letter of Credit / Export Payment Methods

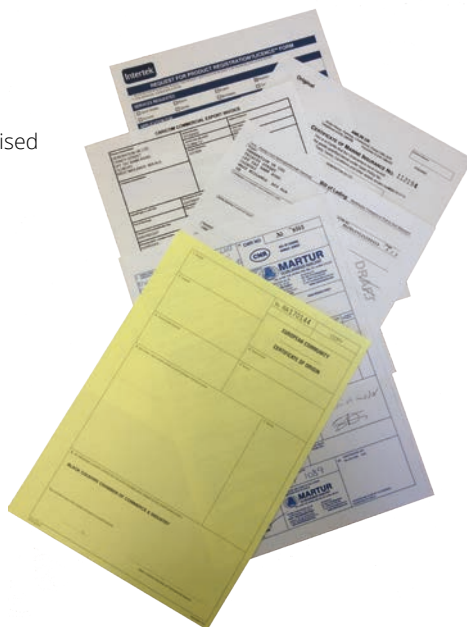



# Altrad Generation Export



## Quality

Vast product range sourced and supplied from high quality UK and Worldwide manufacturers

Products are rigorously tested by approved houses to ISO 9001:2015

All materials supplied meet full British and European Standards which have been batch tested and documented

Major components/systems are independently tested through physical and cyclic loadings, with the results again independently analysed to confirm conformance to British / European standards along with test data and approval documentation

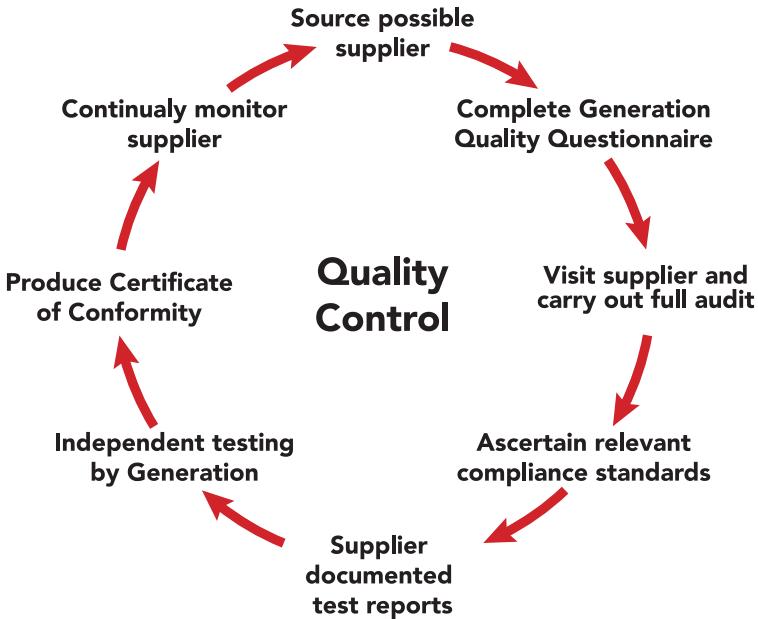





# Conversion Chart

## Distance

1 inch	2.54 centimetres
1 foot	0.3048 metres
1 yard	0.9144 metres
1 rod	5.0292 metres
1 chain	20.1168 metres
1 mile	1.6093 kilometres
1 nautical mile	1.852 kilometres
1 millimetre	0.0394 inches
1 centimetre	0.3937 inches
1 decimetre	0.3281 feet
1 metre	3.2808 feet
1 metre	1.0936 yards
1 kilometre	0.6214 miles
1 kilometre	0.5399 nautical miles

## Surface Area

1 sq. inch	6.4516 sq. centimetres
1 sq. foot	929.03 sq. centimetres
1 sq. yard	0.8361 sq. metres
1 acre	4046.9 sq. metres
1 sq. mile	2.59 sq. kilometres
1 sq. centimetre	0.1550 sq. inches <sup>2</sup>
1 sq. metre	1.1960 sq. yards
1 acre	4840 sq. yards
1 hectare	2.4711 acres
1 sq. kilometre	0.3861 sq. miles

## Weight

1 ounce	28.35 grams
1 pound	0.4536 kilograms
1 hundredweight	50.802 kilograms
1 ton	907.18 kilograms
1 gram	0.0353 ounces
1 hectogram	3.527 ounces
1 kilogram	2.2046 pounds
1 ton	1.016 tonnes

## Volume

1 cu. inch	6.387 cu. centimetres
1 cu. centimetre	0.0610 cu. inches
1 cu. foot	0.0283 cu. metres
1 cu. decimetre	0.035 cu. feet
1 cu. yard	0.7646 cu. metres
1 cu. metre	1.3080 cu. yards

## To Convert

inches to centimetres	2.54
feet to metres	0.3048
yards to metres	0.9144
miles to kilometres	1.609344
sq. inches to sq. centimetres	6.4516
sq. metres to sq. feet	10.7639
sq. miles to sq. kilometres	2.58999
acres to hectares	0.404678
cu. inches to cu. centimetres	16.3871
cu. inches to litres	0.016387
cu. feet / min to litres / min	28.3168
imperial gallons to litres	4.546
ounces to grams	28.3495
pounds to grams	453.592
pounds to kilograms	0.4536
tons to kilograms	1016.05
centimetres to inches	0.393701
metres to feet	3.2808
metres to yards	1.09361
kilometres to miles	0.621371
sq. centimetres to sq. inches	0.155
sq. feet to sq. metres	0.092903
sq. kilometres to sq. miles	0.386103
hectares to acres	2.47101
cu. centimetres to cu. inches	0.0610237
cu. metres to cu. feet	35.3147
litres to cu. inches	61.024
litres/min to cu. feet / min	0.0353
litres to imperial gallons	0.219969
grams to ounces	0.035274
grams to pounds	0.00220462
kilograms to pounds	2.20462
kilograms to tons	0.0009842

## Multiply By



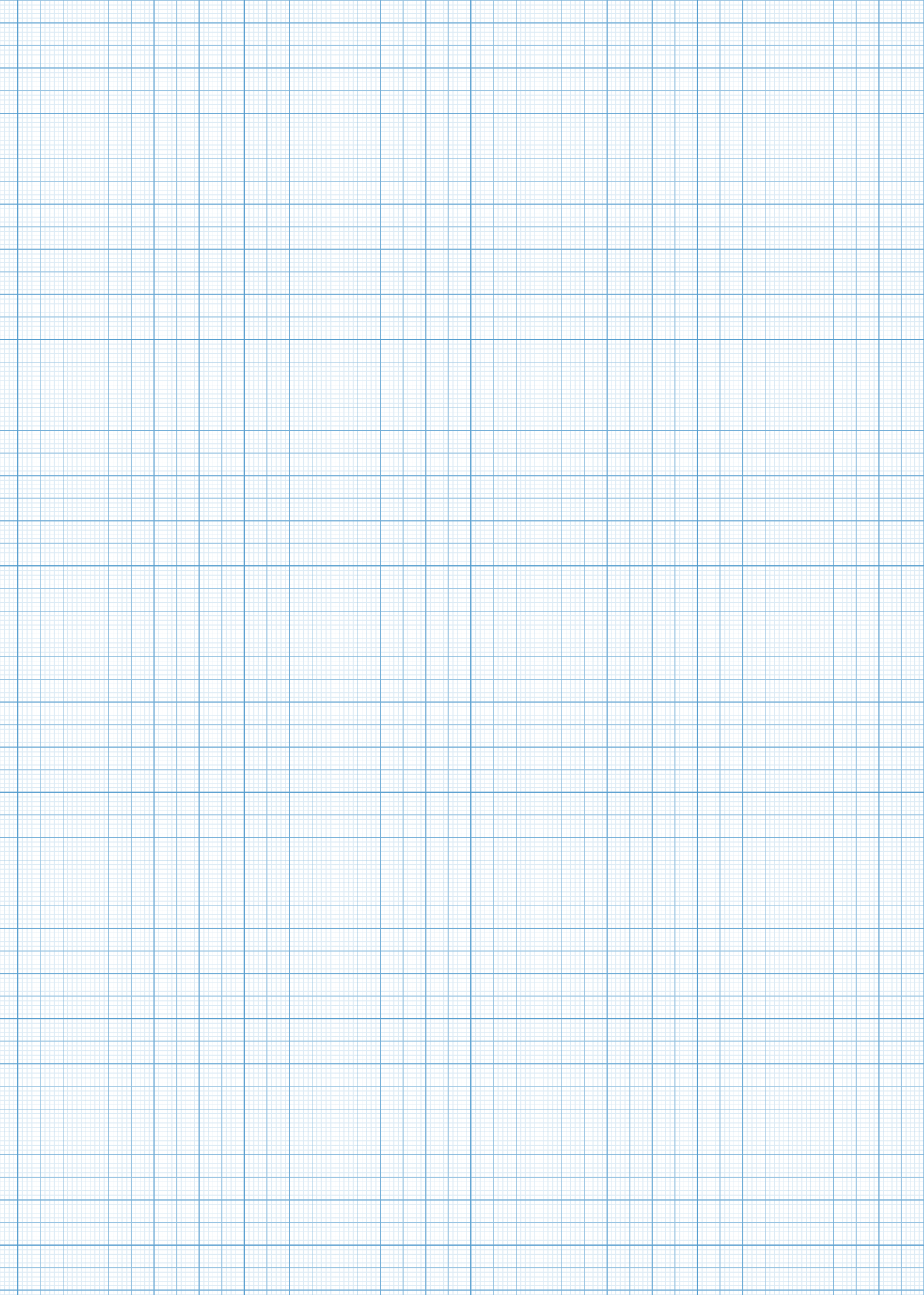



**SCAN ME  
TO FIND**



**YOUR LOCAL  
BRANCH**



**GENERATION  
HIRE & SALE**

Generation UK Ltd.  
Head Office, Trinity Street, Off Tat Bank Road, Oldbury, West Midlands, B69 4LA - United Kingdom  
Tel. 0121 543 2950 - Fax. 0121 543 2953 - [enquiries@generationuk.co.uk](mailto:enquiries@generationuk.co.uk)  
[www.altradgeneration.com](http://www.altradgeneration.com)