

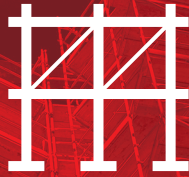

ALTRAD GENERATION

HIRE & SALE



SCAFFOLDING



ALTRAD

Altrad Generation Hire & Sale

Support for Construction & Industry

Altrad Generation is the UK's leading supplier of: Scaffolding, Temporary Fencing, Light Access, Edge Protection, Safety Decking and Groundworks for hire and sale.

OUR CUSTOMER COMMITMENT IS TO DELIVER:



BEST QUALITY

We work closely with our suppliers to ensure consistent product quality every time. All our products are specified to meet or exceed statutory requirements, verified by our Quality Assurance team.



BEST AVAILABILITY

Our nationwide branch network, transport fleet and stock holding ensure we can supply your equipment needs. What, When and Where you need equipment.



BEST PARTNERSHIP

We can take care of all your equipment needs; supplemented by a full range of engineering, design, specification and business services. Our focus is to work together, supporting the growth of your business.



BEST VALUE

Our global supply chain, purchasing and lean business means we don't pass on unnecessary costs to you. We aim to provide consistently low prices and the best value when you buy or hire from us.

Contents

Scaffolding



Scaffold Tube	5
Scaffold Fittings.....	6-8
Scaffold Boards.....	9-10
Aluminium & Steel Beams	11-17
Loading Bay Gates	18-19
Scaffold Ancillaries	20-23
Brickguards	24
Scaffold Tools	25-26
Sheeting & Debris Netting.....	27-32
Scaffold Storage.....	33
Q-Clamps	34-38

Disclaimer

Whilst Generation (UK) Ltd has taken every reasonable effort to ensure the information contained within this publication is correct and complete at the time of printing, you should be aware that there will be periodical changes and Generation (UK) Ltd does not accept any liability for any inconvenience, loss or damage caused as a result of any inaccuracy or omission within this publication.

Copyright

No unauthorised reproduction of any images, text or other matter contained herein is permitted. All rights are expressly reserved, including copyright, design right, moral and patent rights (where applicable). We reserve the right to take legal action in respect of any infringement of said rights.

Scaffolding

Scaffold Tube

Scaffold Fittings

Scaffold Boards

Aluminium & Steel Beams

Loading Bay Gates

Scaffold Ancillaries

Brickguards

Scaffold Tools

Sheeting & Debris Netting

Scaffold Storage

Q-Clamp

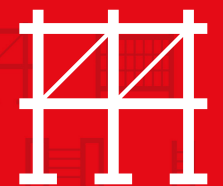



Scaffold Tube



Altrad Generation supplies a number of scaffold tube options including both standard 4mm EN39 and 3.2mm High Yield Steel Tube or Aluminium EN 10219-1 in a range of lengths that are compatible for both commercial and private building projects. If you're not sure what Grade of scaffold tube you require, contact your local branch for more information. We're happy to help.

4mm Hot Dipped Galvanised Tube

Available in various lengths up to 6.40m (21') Fully conforming to EN39:2001 Grade S235GT 48.3mm diameter x 4mm nominal wall thickness. Product Tested and Certified

Code	Length	Code	Length	Code	Length
015205	5'	015210	10'	015221	21'
015206	6'	015213	13'		
015208	8'	015216	16'		

3.2mm High Yield Galvanised Tube

Available in various lengths up to 6.40m (21') Fully conforming to BS EN10219-1 Grade S355J0H 48.3mm diameter x 3.2mm nominal wall thickness. Product Tested and Certified

Code	Length	Code	Length	Code	Length
016905	5'	016910	10'	016921	21'
016906	6'	016913	13'		
016908	8'	016916	16'		

High Quality Aluminium Tube

Available in lengths up to 6.09m (20') Conforms EN755-2 Grade 6082 T6 48.3mm diameter x 4mm nominal wall thickness. Product Tested and Certified

Code	Length	Code	Length	Code	Length
015305	5'	015310	10'	015320	20'
015306	6'	015313	13'		
015308	8'	015316	16'		



Scaffold Fittings

EN 74-1B



Code	026001
Desc.	Drop Forged Double Coupler
Wt.	1.00kg

EN 74-1A



Code	026002
Desc.	Drop Forged Swivel Coupler
Wt.	1.00kg

BS 1139.2.2



Code	026003
Desc.	Drop Forged Putlog Coupler
Wt.	0.60kg

EN 74-1A



Code	026124
Desc.	Pressed Steel Double Coupler
Wt.	1.00kg

EN 74-1A



Code	026125
Desc.	Pressed Steel Swivel Coupler
Wt.	1.00kg

BS 1139.2.2



Code	026126
Desc.	Pressed Steel Putlog Coupler
Wt.	0.60kg

EN 74-1B

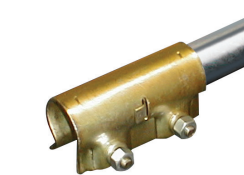

Code	026005
Desc.	Pressed Sleeve
Wt.	1.10kg

BS 1139.2.2



Code	026006
Desc.	Pressed Joint Pin
Wt.	1.10kg

AS 1576.1

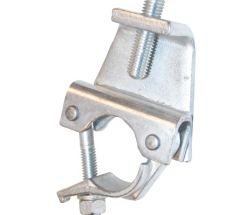

Code	026201
Desc.	Girder Coupler (Use in Pairs)
Wt.	1.56kg



Scaffold Fittings

EN 74-1A



Code	026030
Desc.	Band & Plate
Wt.	2.00kg



Code	045040
Desc.	Board Clamp
Wt.	0.60kg



Code	045038
Desc.	Limpet Clamp
Wt.	0.60kg



Code	046911 & 046107
Desc.	Restraining Eye
Dim.	23mm x 120mm 23mm x 160mm



Code	046106
Desc.	Restraining Eye
Dim.	50mm x 160mm



Code	-
Desc.	Nylon Plugs
Dim.	-



Code	026007
Desc.	Toe Board Clip
Wt.	0.20kg



Code	026009
Desc.	Putlog Head
Wt.	0.40kg

EN 74-1A



Code	048072
Desc.	External Hook Coupler
Wt.	1.03kg

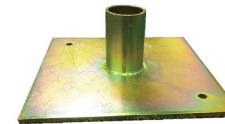

Code	026016
Desc.	British Standard Base Plate
Wt.	0.90kg

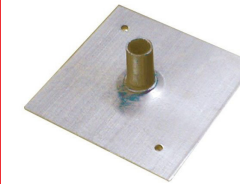

Code	026004
Desc.	Base Plate Tube
Wt.	0.40kg

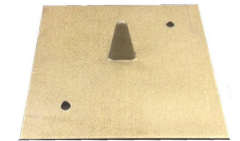

Code	026008
Desc.	Pressed Base Plate
Wt.	0.40kg

AS 1576.1



Code	048071
Desc.	Internal Hook Coupler
Wt.	0.80kg



Code	026040
Desc.	Oyster Coupler
Wt.	0.70kg



Code	046229
Desc.	Roofing Coupler
Wt.	1.00kg



Code	045039
Desc.	Ladder Clamp
Wt.	1.00kg

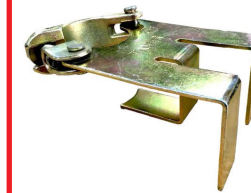

Code	026510
Desc.	Tamer® Fitting
Wt.	-



Code	026511
Desc.	Klawz Fitting
Wt.	-



Scaffold Fittings



Scaffold Boards

Timber Boards



All our boards are made to the exacting standards of BS 2482:2009 using visually or machine graded timber with support spans of up to 1.2m or machine stress graded with support spans of up to 1.5m.

Available in standard industry sizes, all scaffold boards can be branded and banded with your company's name upon request as well as nail-plated.

Code	Description	Depth	Width	Weight
034009	3ft Timber Scaffold Board - 1.2m Support	38mm	225mm	4.26kg
034007	4ft Timber Scaffold Board - 1.2m Support	38mm	225mm	5.68kg
034008	5ft Timber Scaffold Board - 1.2m Support	38mm	225mm	7.10kg
034006	6ft Timber Scaffold Board - 1.2m Support	38mm	225mm	8.52kg
034002	8ft Timber Scaffold Board - 1.2m Support	38mm	225mm	11.36kg
034005	10ft Timber Scaffold Board - 1.2m Support	38mm	225mm	14.20kg
034001	13ft Timber Scaffold Board - 1.2m Support	38mm	225mm	18.46kg

Code	Description	Depth	Width	Weight
034105	5ft Timber Scaffold Board - 1.5m Support	38mm	225mm	7.70kg
034106	6ft Timber Scaffold Board - 1.5m Support	38mm	225mm	9.20kg
034108	8ft Timber Scaffold Board - 1.5m Support	38mm	225mm	12.30kg
034110	10ft Timber Scaffold Board - 1.5m Support	38mm	225mm	15.40kg
034113	13ft Timber Scaffold Board - 1.5m Support	38mm	225mm	20.00kg

Code	Description	Depth	Width	Weight
034013	1" Scaffold Board Bands	-	-	0.09kg
034018	18inch / 450mm Sole Pads	38mm	225mm	2.00kg



Scaffold Boards

Steel Scaffold Boards - Sale Only

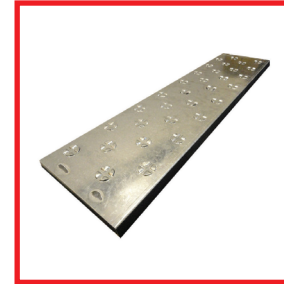

Available in various lengths between 3ft and 13ft.
Conforms to BS EN 12811-1.

Fire retardant and long lasting, perfect for harsh environments and use in onshore and offshore facilities.

Code	Description	Depth	Width	Weight
037003	3' Galvanised Steel Board	38mm	225mm	5.10kg
037004	4' Galvanised Steel Board	38mm	225mm	6.80kg
037005	5' Galvanised Steel Board	38mm	225mm	8.50kg
037006	6' Galvanised Steel Board	38mm	225mm	10.20kg
037008	8' Galvanised Steel Board	38mm	225mm	13.60kg
037010	10' Galvanised Steel Board	38mm	225mm	17.00kg
037013	13' Galvanised Steel Board	38mm	225mm	22.00kg

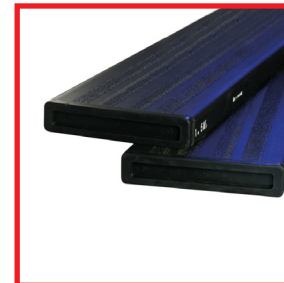

Plastic Scaffold Board (Supadeck)

Supadeck is a unique lightweight decking system that is strong and durable. It is easier, safer and cleaner to use than steel and traditional timber boards.

Supadeck for tubular scaffolding 45mm x 225mm clear spans of at least 1.5m. Weight @ 3.9m - 13kg

Supadeck for batten applications 63mm x 225mm clear spans of at least 2.4m. Weight @ 2.4m - 11.5kg

Code	Description	Depth	Width	Weight
038005	1.5m Supadeck Board	45mm	225mm	6.15kg
038008	2.4m Supadeck Board	45mm	225mm	9.85kg
038010	3.0m Supadeck Board	45mm	225mm	12.30kg
038013	3.9m Supadeck Board	45mm	225mm	16.00kg



Aluminium & Steel Beams

450mm High Capacity Alloy Beam

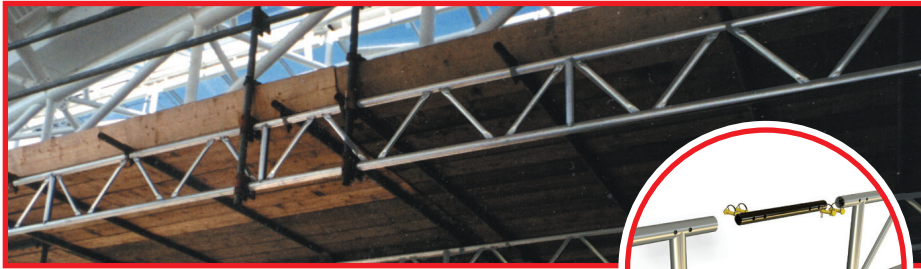

The Aluminium 450mm Beam has been the market leader in the UK & Europe for more than 20 years. It provides significant time and cost savings across a whole range of scaffold structures.

Suspended or mobile platforms, birdcages, protection-decks bridges or temporary roofs are ideal applications for the Aluminium 450mm Beam.

The Aluminium 450mm Beam has been specifically designed to provide the highest possible UDL. The unique design allows connection directly to the node point between the diagonals, achieving maximum loading. This means, in most applications, the lowest number of beams are required. In addition, beams are quickly and simply joined together with straight connectors using fast action spring clips.

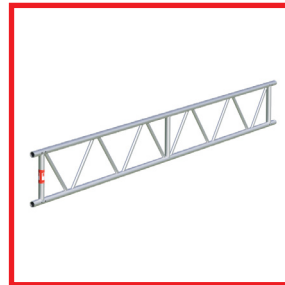

Code	Description	BS EN 1999-1 (1.0m Restraints)		Weight
		Perm. Shear	Perm. Moment	
277499	4.1m x 450mm Beam	11.66kN	20.19kNm	17.00kg
277490	6.1m x 450mm Beam	11.66kN	20.19kNm	23.00kg
277500	8.1m x 450mm Beam	11.66kN	20.19kNm	31.00kg
277631	60mm Spring Clip	-	-	0.03kg
277501	450mm 6 Hole Steel Spigot	-	-	1.13kg

Aluminium & Steel Beams

Asterix 750 Beam

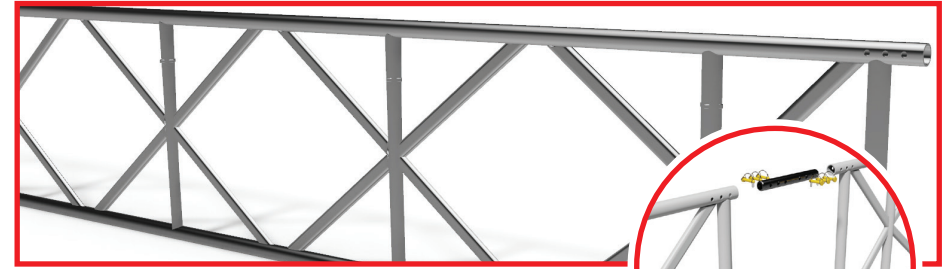

The Asterix 750 Beam is totally compatible with the Diamond Beam with superior capacity and also fits the X-Beam (capacity not equivalent).

All chords and posts are manufactured in traditional scaffold tube size. Vertical posts are provided every 1m on all beam sizes.

The Asterix 750 Beam also offers consistent node spacing when multiple beams are joined. The node points are spaced to allow connection of a standard scaffold fitting at any point.

18 degree, 12 degree and 6 degree ridge beams available.

Consistent diagonal node spacing when multiple beams are joined.

Closed end beams so whole length can be used for support unlike other 750 beams where end support has to be set in 0.5m each side, effectively wasting 1m of beam each time.

Joined using simple spigots and quick release spring clips.

Suitable for use with Temporary Roofing Systems.

Conforms to BS EN 1999-1-1 Eurocode 9

Code	Description	BS EN 1999-1 (1.0m Restraints)		Weight
		Perm. Shear	Perm. Moment	
397010	1.0m x 750mm Beam	23.73kN	41.30kNm	6.94kg
397020	2.0m x 750mm Beam	23.73kN	41.30kNm	12.72kg
397030	3.0m x 750mm Beam	23.73kN	41.30kNm	18.49kg
397040	4.0m x 750mm Beam	23.73kN	41.30kNm	24.27kg
397050	5.0m x 750mm Beam	23.73kN	41.30kNm	11.75kg
397060	6.0m x 750mm Beam	23.73kN	41.30kNm	19.61kg
397001	6 Hole Steel Spigot	-	-	0.70kg
277631	60mm Spring Clip	-	-	0.03kg





Aluminium & Steel Beams

X-Beam



X-Beam is a high strength and high quality alternative to conventional methods. Specially designed for capacity and lightness X-Beams are the safe, labour saving alternative. Suitable for all applications such as crash decks, spine beams, temporary bridges, large span temporary roofs and suspended scaffolds.

Available for both hire and sale they provide a cost effective solution for any application saving erection time and mechanical handling. Beams are erected quickly and more safely where possession times are critical.

Its strength and self-weight allows less associated equipment in the structure.

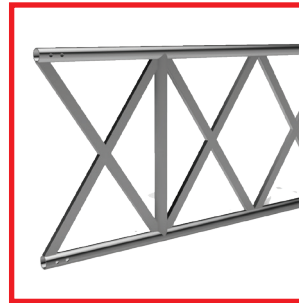

Conforms to BS EN 1999-1-1 Eurocode 9

Code	Description	BS EN 1999-1 (1.0m Restraints)		Weight
		Perm. Shear*	Perm. Moment*	
395001	1.0m x 750mm Beam	35.00kN	33.00kNm	8.00kg
395003	3.0m x 750mm Beam	35.00kN	33.00kNm	24.00kg
395004	4.0m x 750mm Beam	35.00kN	33.00kNm	32.00kg
395010	Spigot c/w Nut and Bolt	-	-	0.69kg

*Varies with span, please refer to full specification.



Aluminium & Steel Beams

D780mm Alloy Beam

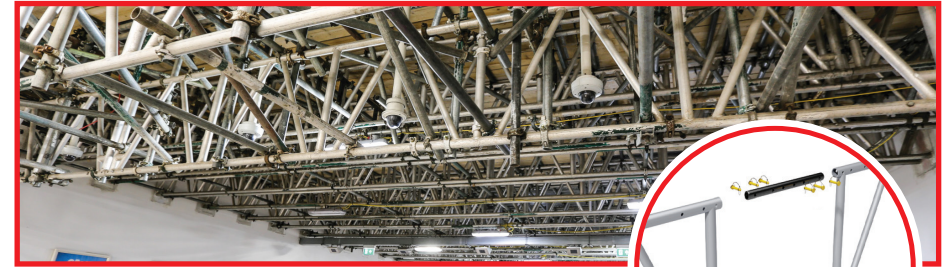

Main structural component for creation of roof spans, also suitable for everyday general purpose applications. The user friendly D78 Beam range offers unrivalled cost to weight ratio and is equally at home in a heavy duty support scaffold or an elegant roofing application

- High strength, low weight and maximum versatility.
- Manufactured in traditional scaffold tube size.
- Vertical posts are provided each 1m on all beam sizes.

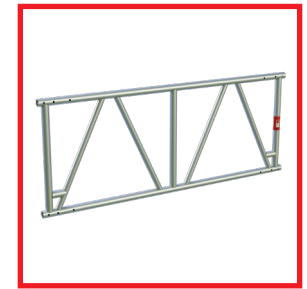

Conforms to BS EN 1999-1-1 Eurocode 9

Code	Description	BS EN 1999-1 (1.0m Restraints)		Weight
		Perm. Shear	Perm. Moment	
440004	0.5m Beam	23.71kN	38.8kNm	4.30kg
440005	1.0m Beam	23.71kN	38.8kNm	6.34kg
440006	2.0m Beam	23.71kN	38.8kNm	11.63kg
440007	3.0m Beam	23.71kN	38.8kNm	16.92kg
440008	4.0m Beam	23.71kN	38.8kNm	22.21kg
440009	5.0m Beam	23.71kN	38.8kNm	27.50kg
440010	6.0m Beam	23.71kN	38.8kNm	32.79kg
440071	6 Hole Steel Spigot	-	-	1.49kg
277631	60mm Spring Clip	-	-	0.03kg



Aluminium & Steel Beams

780mm Aluminium Beam



The 780 Aluminium Beam is high strength, low weight and has maximum versatility. The beam range has overall depths of 0.78m and comes in lengths from 2m to 6m.

All member components are manufactured in traditional scaffold tube size and vertical posts are provided each 1m on all beam sizes. It also has consistent node spacing when multiple beams are joined, and node points are spaced to connect a standard scaffold fitting at any point.

The beam can be joined using the Altrad Generation Spigot Connector.

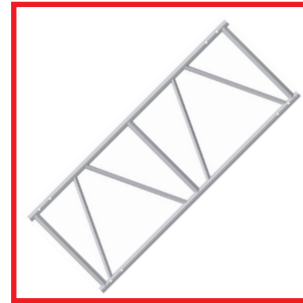

Code	Description	BS EN 1999-1 (1.0m Restraints)		Weight
		Perm. Shear	Perm. Moment	
440007	3.0m x 780mm Beam	30.70kN	36.50kNm	16.70kg
440008	4.0m x 780mm Beam	30.70kN	36.50kNm	22.00kg
440009	5.0m x 780mm Beam	30.70kN	38.80kNm	27.40kg
440010	6.0m x 780mm Beam	30.70kN	36.50kNm	32.70kg
440071	6 Hole Steel Spigot	-	-	0.08kg
277631	60mm Spring Clip	-	-	0.03kg



Aluminium & Steel Beams

1.33m Heavy Duty Asterix Alloy Beam



Single Beam Lines, Massive Spans

Multiple beam lines omitted for most applications, greatly simplifies lacing and bracing, massive reduction in fittings and labour.

Special Design, Quality Manufacture

Optimum arrangement of internal members for maximum capacity and consistent node spacing. All beams closed end for stability and strength, spigot jointed.

Brace with System or Tube and Fittings

Asterix HD Beam depth enables use of system K frames for both plan and section bracing, meaning large beams can be braced in minutes. Alternatively, traditional tube and fittings can be used for both lacing and bracing. Unlike most other scaffold beams on the market today it is permissible to connect scaffold couplers to the posts of Asterix HD.

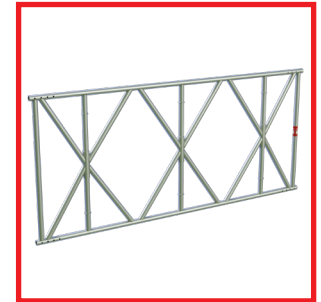

Code	Description	BS EN 1999-1 (1.0m Restraints)		Weight
		Perm. Shear	Perm. Moment	
396055	0.55m x 1.33m Beam	32.60kN	102.20kNm	6.33kg
396100	1.0m x 1.33m Beam	32.60kN	102.20kNm	13.33kg
396200	2.0m x 1.33m Beam	32.60kN	102.20kNm	22.60kg
396300	3.0m x 1.33m Beam	32.60kN	102.20kNm	31.87kg
396400	4.0m x 1.33m Beam	32.60kN	102.20kNm	41.13kg
396900	8 Hole Steel Spigot	-	-	1.44kg
277631	60mm Spring Clip	-	-	0.03kg



Aluminium & Steel Beams

Ladder Beams



Steel Ladder Beams are an economical, versatile structural steel support beam available for hire or sale, fully compatible with traditional tube and fittings and used to enable clear spans to be constructed between adjacent scaffolding structures. Ideally suited to long term applications and used extensively on high level pavement gantries, heavy duty loading bays, cantilevered structures, temporary shores, truss out scaffolds and slung / suspended structures.



Also Available Galvanised and Aluminium Ladder Beams

Call your nearest branch for further details

Max moment are for spans over 3.7m

Code	Description	BS EN 1999-1 (1.0m Restraints)		Weight
		Perm. Shear	Perm. Moment	
055015	6ft (1.8m) Steel Ladder Beam	20.00kN	12.70kNm	18.40kg
055073	8ft (2.4m) Steel Ladder Beam	20.00kN	12.70kNm	24.50kg
055070	10ft (3.0m) Steel Ladder Beam	20.00kN	12.70kNm	30.60kg
055084	13ft (3.9m) Steel Ladder Beam	20.00kN	12.70kNm	40.00kg
055075	16ft (4.8m) Steel Ladder Beam	20.00kN	12.70kNm	49.00kg
055077	21ft (6.4m) Steel Ladder Beam	20.00kN	12.70kNm	64.20kg

Loading Bay Gates



Altrad Generation has a wide range of ancillary components which add safety to both system and tube and fitting scaffolds. Loading Bay Gates, Safety Handrail Gates and Ladder Locks are available to provide safety of operatives who work on finished scaffolds.

Loading Bay Gate Arms are supplied in pairs, manufactured in mild-steel and power coated for high durability.

All Loading Bay Gates can be erected with Standard Scaffold Tubes, Boards and Brick Guards.



Double Handrail Staysafe

To be used in pairs, allowing two handrails to be used as well as allowing a Toe Board (Scaffold Board) to be fixed.

Fully compliant to
TG20 and BS EN 13374

- Full box section frame with three welded half coupler scaffold fittings
- Operates within a 7 board loading bay
- No protrusion into the working platform
- 2185mm height required
- 1500mm loading depth
- 21kg per arm

Code	Description	Weight
278202	Double Handrail Staysafe	20.00kg



Loading Bay Gates



Triple Handrail Staysafe

To be used in pairs, allowing three handrails to be used.

Fully compliant to
TG20 and BS EN 13374

- Full box section frame with two welded half coupler scaffold fittings and a toe board bracket
- Operates within a 6 board loading bay
- No protrusion into the working platform
- 1975mm height required
- 1350mm loading depth
- 20kg per arm
- Ideal for system scaffolding

Code	Description	Weight
278203	Triple Handrail Staysafe	14.70kg



'M' Loading Bay

To be used with tube and fittings. Additional fittings will be required to secure the gate.

Rear Guardrails must be fitted to comply with
TG20 and BS EN 13374

- Box section and round tube frame, fully braced with 6mm flat bar
- Operates within a 7 board loading bay
- 1850mm height required (excluding scaffolding fittings)
- 1500mm loading depth
- 13kg per arm

Code	Description	Weight
278230	'M' Loading Bay Arm	20.00kg
278231	'M' Loading Bay Gate	20.00kg



Scaffold Ancillaries

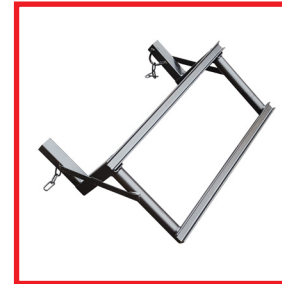

Code	046224
Desc.	Rubbish Chute Fixing Frame
Wt.	0.90kg



Code	046222
Desc.	Top Hopper Rubbish Chute
Wt.	10.00kg



Code	046221
Desc.	Rubbish Chute
Wt.	9.00kg



Code	046223
Desc.	Side Entry Rubbish Chute
Wt.	-



Code	103116
Desc.	Customisable Gladtag
Wt.	-



Code	207005
Desc.	6 Ton Standard Base Jack
Wt.	4.70kg



Code	207200
Desc.	6 Ton Swivel Base Jack
Wt.	4.30kg

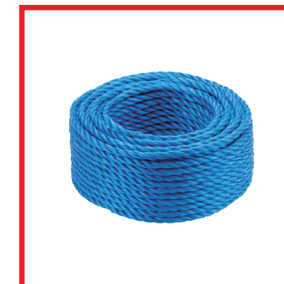

Code	046078/9
Desc.	Rope - Sisal & Polypropylene
Wt.	0.10kg



Code	026013
Desc.	8" Rubber Solid Scaffold Castor
Wt.	6.50kg



Scaffold Ancillaries



Code	046037
Desc.	10" Gin Wheel
Wt.	5.00kg



Code	046235/6
Desc.	Sign Board Frames
Wt.	5.00kg



Code	046520
Desc.	Warning Tape Adhesive
Wt.	0.10kg



Code	048065
Desc.	2m Foam Sleeving
Wt.	0.50kg

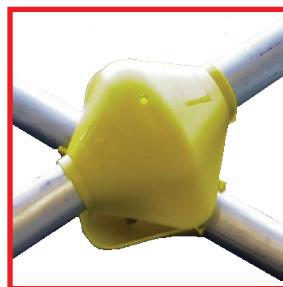

Code	026000
Desc.	Armadillo Fitting Cover
Wt.	0.12kg



Code	046049/50
Desc.	Tube End & Thread Caps
Wt.	0.01kg



Code	135065
Desc.	Alu. Scaffolders Step SG4
Wt.	6.20kg



For information on ladders see the **Ladders & Builders Products** Section



Scaffold Ancillaries

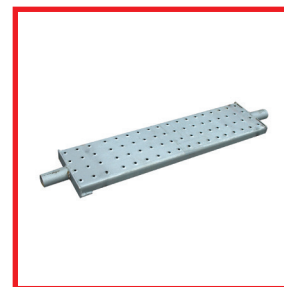

Steel Stair Tread

Code	Description	Length	Weight
046027	Steel Stair Tread	900mm	7.20kg
046028	Steel Stair Tread	1050mm	8.90kg
046029	Steel Stair Tread	1220mm	10.50kg



Clip Lubricant

Code	Description	Length	Weight
040005	Clip Lubricant	5 Litres	5.00kg
040020	Clip Lubricant	20 Litres	20.00kg
040210	Clip Lubricant	208 Litres	208.00kg



Klipp-It is an all new universal clip system designed specifically for the attachment of various objects onto scaffolding. Unlike many current methods of fixing, it is quick, safe and secure to attach and detach.

It's unique design of slots and voids is ideal for the quick and safe fixing of brick guards and debris sheeting, cables, banners, lights, signage, work packs and other items which have a keder edging strip.

Available In Other Colours

Code	045123
Desc.	Klipp-It
Wt.	-

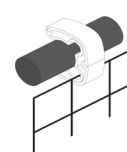

BRICK GUARDS



BANNERS & DEBRIS SHEETING



CABLE MANAGEMENT



SAFETY SIGNAGE



LIGHTING EQUIPMENT



Scaffold Ancillaries

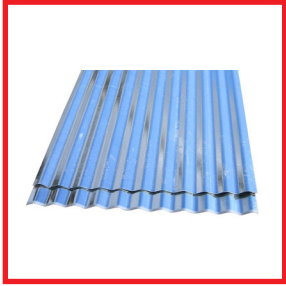

Corrugated Iron Sheeting

Std Gauge	Imperial Thickness	Metric Thickness
22	0.0275" (0.0248")	0.70mm (0.63mm)
24	0.0236" (0.0213")	0.60mm (0.54mm)
26	0.0197" (0.0177")	0.50mm (0.45mm)



Universal Friction Clamp

The Universal Friction Clamp can be fitted to horizontal, inclined or vertical tubular member of any diameter from 500mm upwards. Although it will have some resistance to loading applied parallel to the axis of the tubular member, it is intended to support loading applied at right angles to the axis. Maximum permissible applied load 3.kN and out of balance moment of 4.5kNm when applied.

Code	Description	Length
046027	Universal Friction Clamp	900mm
046028	Universal Friction Clamp	1050mm

To Calculate the length of chain required on a friction clamp:
Pipe Dia. x 3.14 x 2 = min chain length

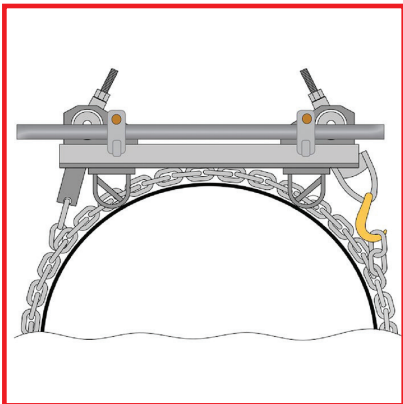

Diameter	Chain Length
500mm - 600mm	4000mm
600mm - 900mm	6000mm
900mm - 1200mm	8000mm

1200+ information available upon request



Brickguards

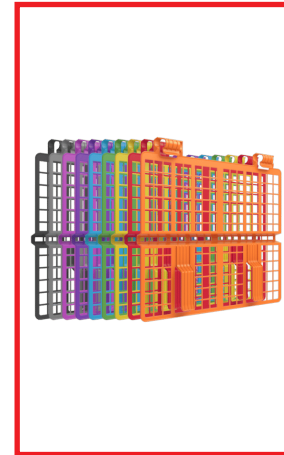

J.Mac Plastic Brickguards

Meets with TG20 and BSEN12811 standards. The 'V' groove allows the Brickguard to run past scaffolding standards and over the rosettes. 2no. Toe Board Connectors give more security and improved fixing. It is also longer in height than other Brickguards on the market.

(J.Mac 945mm versus Max @ 840mm).

Code	Description	Weight
045130	J.Mac Black Plastic Brickguard	1.85kg
045131	J.Mac Blue Plastic Brickguard	1.85kg
045132	J.Mac Red Plastic Brickguard	1.85kg
045133	J.Mac Green Plastic Brickguard	1.85kg
045134	J.Mac Yellow Plastic Brickguard	1.85kg
045135	J.Mac Coloured Plastic Brickguard	1.85kg



MAX Brickguards

Manufactured and tested to EN12811-1:2003 standards. Complete one-piece construction with no separate parts to count or lose. Made from high grade impact modified polypropylene. A built in Toe Board Clip maximises safety even in high winds.

Code	Description	Weight
045108	Black Max Guard	1.00kg
045109	Blue Max Guard	1.00kg

Available In Other Colours



Scaffold Tools

Large Stocks Available Nationwide

Altrad Generation provides a full range of scaffolders tools including spanners, ratchets and hammers - we are sure to have what you need. For our full range of tools, please contact your nearest branch on **0800 779 7113**.



Code	046410
Desc.	7/16" Poker Handle Spanner
Wt.	0.60kg



Code	046412
Desc.	7/16" Cromwell Spanner
Wt.	0.50kg



Code	046415
Desc.	7/16" Burton Plain Spanner
Wt.	0.50kg



Code	046413
Desc.	1/2" Poker Handle Spanner
Wt.	0.60kg



Code	046414
Desc.	1/2" Cromwell Spanner
Wt.	0.50kg

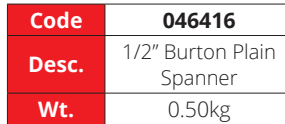

Code	046416
Desc.	1/2" Burton Plain Spanner
Wt.	0.50kg



Code	046411
Desc.	7/16" Chrome Flat Handle Spanner
Wt.	0.60kg



Code	046428
Desc.	Podger Hook
Wt.	0.50kg



Code	046418
Desc.	Podger Hammer
Wt.	-



Scaffold Tools



Code	046074
Desc.	Steel Magnetic Spirit Level
Wt.	0.20kg



Code	046417
Desc.	7/16" Ratchet Spanner
Wt.	0.30kg



Code	046425
Desc.	5m Steel Tape Measure
Wt.	0.10kg



Desc.	Various Belts, Frogs and Holders are available to suit all tools.
--------------	---



Desc.	Helmets Find more information in Safety Products
--------------	--



Desc.	Harnesses Find more information in Safety Products
--------------	--



Sheeting and Debris Netting



Monarflex Super T Plus

Monarflex Super T Plus is used for all types of long-term projects and is designed exceeding 12 months and conforms to BS7955:1999, BS8410:2007.

The combination of high quality components form a tough and durable sheeting option for very rough and extreme working conditions.

Firesmart option also available.

Code	Dimensions	Tensile Strength	Flame Retardant	Weight
046348	2.0m x 45.0m*	>630N/ 50mm	LPS 1207 and 1215 Cert No. 572d	34.00kg



Monarflex Scaffband

Monarflex Scaffband can be used for all types of short term projects up to a max. duration of 6 months. The product is designed for normal weather conditions found in urban area with low rise buildings.

Designed to be installed with the Monarflex Flexitie fixing. By using Monarflex Scaffband Clear you can meet deadlines and avoid economical surprises regardless of the weather and be safe in the knowledge that it fulfils all relevant British Standards like BS 7955:1999 and BS 8410:2007.

Code	Dimensions	Tensile Strength	Flame Retardant	Weight
046343	2.0m x 45.0m	>630N/ 50mm	-	19.00kg
046344	3.0m x 45.0m	>630N/ 50mm	-	28.00kg



Monarflex Scaffband Flamesafe

Monarflex Scaffband Flamesafe is made from a three ply composition with the two outer layers being made from a weather resistant LDPE with flame retarder additives that encapsulates a strong multifilament polyester (PET) grid which forms the weather protection. On top of the sheet there are fixing bands of super high strength weave with a double coating over the bands to provide high durability. The bands are in pre-set patterns and with pre-made holes per 100mm making it fit virtually any type of scaffold. Conforms to British Standards like BS7955:1999 and BS 8410:2007

Code	Dimensions	Tensile Strength	Flame Retardant	Weight
046345	2.0m x 45.0m	>630N/ 50mm	LPS1215 Cert No. 572D	19.00kg
046346	3.0m x 45.0m	>630N/ 50mm	LPS1215 Cert No. 572D	28.00kg



Sheeting and Debris Netting

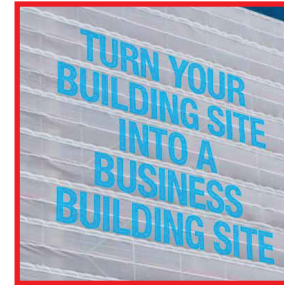

Monarflex Digi-Wrap

Digi-Wrap printing allows you to wrap any building in a powerful, highly visible message - from simple banners featuring your company logo to a full colour image creating a giant billboard.

- Fast production time of 2-3 weeks
- Minimum 6 month life of printed surface
- Sections are easily replaced if damaged



Powerclad Lite

- Effective weather protection and containment system
- Improves working environment and site safety
- Woven reinforcement with waterproof coating
- Excellent low-temperature characteristics
- Digital printing for branding opportunities
- Double banding which allows for better fixing and overlaps

Code	Weight	Dimensions	Tensile Strength	Flame Retardant
-	170gsm	2.0 x 45m, 2.2 x 40m, 3.0 x 45m, 3.25 x 36m, 3.75 x 36m	Warp500 N/500mm Weft 500 N/50mm	-



Sheeting and Debris Netting



Powerclad Flame Retardant Sheeting

- Effective weather protection and containment system
- Improves working environment and site safety
- Woven reinforcement with waterproof coating and
- Excellent low-temperature characteristics
- Digital printing for branding opportunities
- Certificated to BS 5867 Part 2B and BS 476 Part 12C

Code	Weight	Dimensions	Tensile Strength	Flame Retardant
-	170gsm	2.0 x 45m, 2.2 x 40m, 3.0 x 45m,	Warp >630 N/50mm Weft >630 N/50mm	LPS 1215 Cert No 965B LPS 1207 Cert No 965A



Acoustic Noise Barrier Flame Retardant Sheeting

Measurable noise reduction minimises environmental impact close to noise sensitive sites. Powerclad Acoustic Sheeting features a special sound absorbing foam which provides both thermal insulation and sound absorption. Also available to fit perimeter fence panels.

Compliant to BS7955

Code	Weight	Dimensions	Tensile Strength	Flame Retardant
-	-	2.2m x 10m	-	EN13501-1 Class E



Insulated Sheeting Flame Retardant Sheeting

Insulated sheeting incorporates cellular air cells which provide thermal insulation for improved working environments and those which require controlled atmospheres. It is widely used on projects where low temperatures and inclement weather conditions prevail. These materials are subject to minimum order quantities.

Compliant to BS7955

Code	Weight	Dimensions	Tensile Strength	Flame Retardant
-	-	2.2m x 20m 2.7m x 20m	-	DIN 4102 B1



Sheeting and Debris Netting



Filter Sheeting Flame Retardant

Closely woven air permeable mesh to contain debris and dust, dry out interior works, disperse paint solvents and air pressure during stone cleaning or shot-blasting. Filter sheeting is particularly recommended for exposed locations with high risk of wind acceleration.

Compliant to BS7955

Code	Weight	Dimensions	Tensile Strength	Flame Retardant
-	-	3.12m x 50m	-	BS476 part 12C (Complies with LPS 1215 sect 3.1.1)



Vented Sheeting/ Perimeter Mesh Fencing

A more open weave than filter sheeting, Vented Sheeting provides higher air permeability. It is used to dry out interior works and disperse paint solvents and air pressure during stone cleaning or shot-blasting. It is also suitable as perimeter mesh fencing as it reduces wind forces on the fence. Also available in black for outdoor events and can be printed for corporate branding.

Compliant to BS7955

Code	Weight	Dimensions	Tensile Strength	Flame Retardant
-	-	1.76m x 50m 2m x 45m	-	BS476 Part 12C (complies with LPS 1215 Sect 3.1.1)



Sheeting and Debris Netting



Custom Printing	Colours	Minimum Order	Print Area
Flexoprint - Repeat logo on scaffold sheeting and meshes	Standard 1 or 2 colour printing	30 rolls	Max Width 1070mm Max Height 730mm Repeats 1270mm
For projecting effective corporate branding. Largest print area in the industry			
Digiprint - Large logo on scaffold sheeting and meshes	Full-colour printing	No minimum order quantity	Unlimited
Wide format printing on scaffold sheeting and mesh. Ideal for promoting a development or project.			
Digiprint - Very large building wraps on PVC	Full-colour printing	No minimum order quantity	Unlimited
Wide format printing on PVC sheeting or open mesh to any size.			



Sheeting and Debris Netting



Fine Mesh Debris Netting

Available in a range of colours in sizes 2m x 50m and 3m x 50m

Altrad Generation concentrate on only supplying high quality, long life debris netting.

Altrad Generation's sheeting and debris netting meets and exceeds all relevant EN and BS Standards.

Colours Available

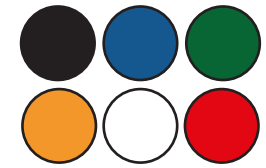

Sheeting and Debris Netting Ties

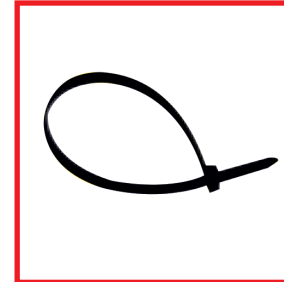

Code	046340
Desc.	Cable Ties
Wt.	0.22kg

For use with debris netting.

100 ties per pack.
1 Pack per roll.



Code	046341
Desc.	Flexitie
Wt.	1.50kg

046340 For use with Scaffband and Tri-Flex Sheeting.

100 ties per pack.
1 Pack per roll.



Code	046032
Desc.	Anchor & Strap
Wt.	2.00kg

Recommended for use with Monarflex Extreme Firesmart & Extreme Super T Plus.

100 ties per pack.
1 Pack per roll.



Scaffold Storage



U - Stacker

Altrad Generation's U-Stacker is designed to be used for the storage of tubes and boards as well as providing a safe and cost effective alternative to the traditional post pallet. Tested and designed to the structural design requirements of BS EN 2811 Temporary Works Equipment and BS EN 1993-11:2005 Eurocode 3 Design of Steel Structures.

***Based on 6.4m tube.**

Code	Description	Weight	Max Capacity	Stacking
041001	Size 1 U - Stacker	4.00kg	48 Tubes	5 Units High
041002	Size 2 U - Stacker	5.00kg	78 Tubes	3 Units High
041003	Size 3 U - Stacker	7.00kg	50 Boards	3 Units High



Code	207777
Desc.	Steel Stillage
Wt.	29.50kg



Code	025555
Desc.	Steel Bin
Wt.	50.00kg



Code	026325
Desc.	Fitting Sack
Wt.	2.50kg



Q-Clamps

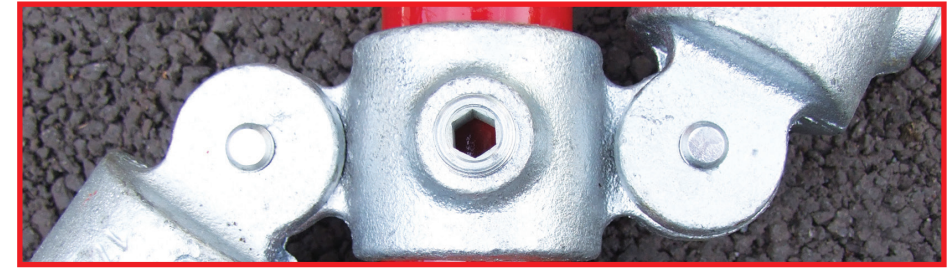

Over 50 types of Q-Clamps available for all uses and various tube sizes. Please visit our website or contact your nearest branch for the full range of fittings.

Size	Tube Diameter (mm O/D)	Normal Bore
1	26.9	¾"
2	33.7	1"
3	42.4	1¼"
4	48.3	1½"
5	60.3	2"

Note:

Size 4 is standard scaffold tube

TÜV RHEINLAND Product Safety Type Approval Cert No: B061161671001

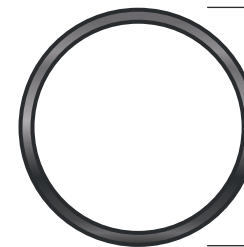

48.3mm Tube Dimension

Galvanised tube available in Various lengths and thicknesses.

Galvanised Blackheart Malleable Iron fittings to BS6681, Grade B32-10 with galvanising to BS EN 1461:1999.

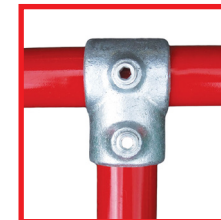

013500
Q-Clamp 101-4

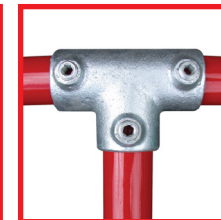

013501
Q-Clamp 104-4

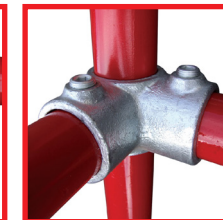

013503
Q-Clamp 116-4

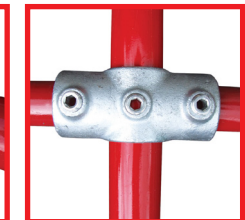

013505
Q-Clamp 119-4



Q-Clamps

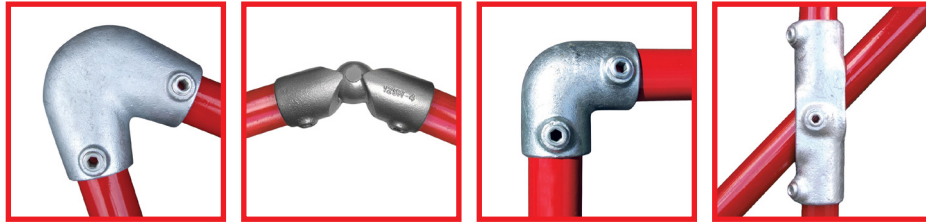

013433 Q-Clamp 123-4	013347 Q-Clamp 125-4M	013507 Q-Clamp 125-4	013504 Q-Clamp 126-4
--------------------------------	---------------------------------	--------------------------------	--------------------------------

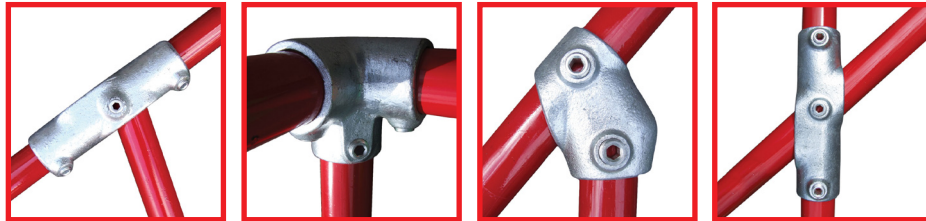

013506 Q-Clamp 127-4	013509 Q-Clamp 128-4	013511 Q-Clamp 129-4	013513 Q-Clamp 130-4
--------------------------------	--------------------------------	--------------------------------	--------------------------------

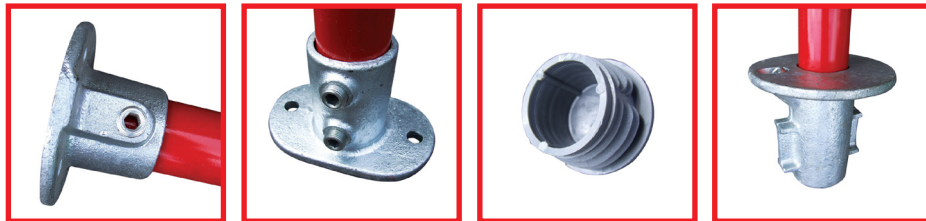

013515 Q-Clamp 131-4	013516 Q-Clamp 132-4	013517 Q-Clamp 133-4	013518 Q-Clamp 134-4
--------------------------------	--------------------------------	--------------------------------	--------------------------------

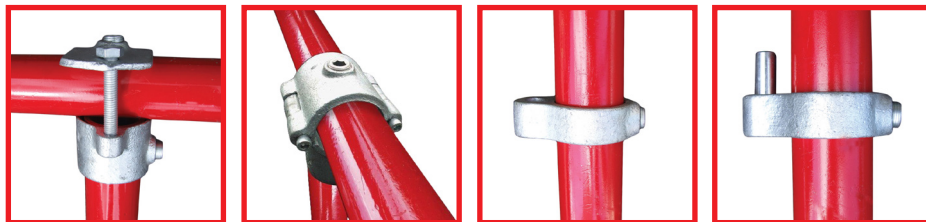

013519 Q-Clamp 135-4	013546 Q-Clamp 136-4	013520 Q-Clamp 138-4	013521 Q-Clamp 140-4
--------------------------------	--------------------------------	--------------------------------	--------------------------------



Q-Clamps

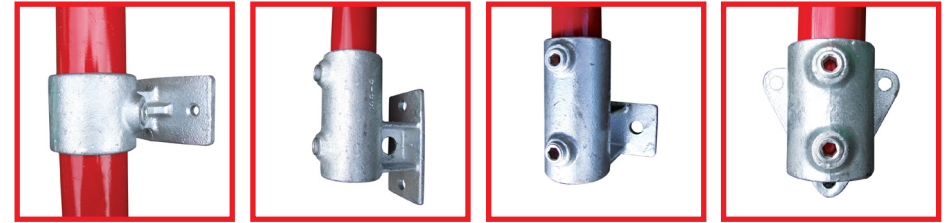

013522 Q-Clamp 143-4	013438 Q-Clamp 144-4	013448 Q-Clamp 145-4	013524 Q-Clamp 146-4
--------------------------------	--------------------------------	--------------------------------	--------------------------------

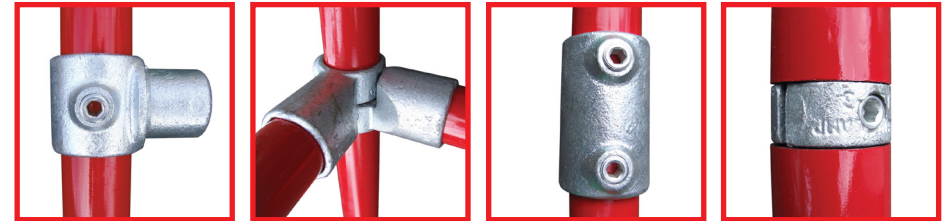

013525 Q-Clamp 147-4	013526 Q-Clamp 148-4	013527 Q-Clamp 149-4	013528 Q-Clamp 150-4
--------------------------------	--------------------------------	--------------------------------	--------------------------------

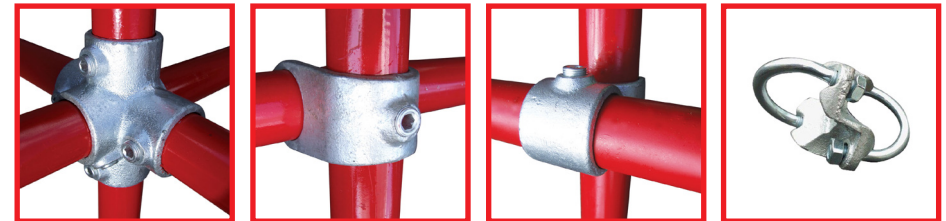

013529 Q-Clamp 158-4	013406 Q-Clamp 160-4	013531 Q-Clamp 161-4	013348 Q-Clamp 161-4M
--------------------------------	--------------------------------	--------------------------------	---------------------------------

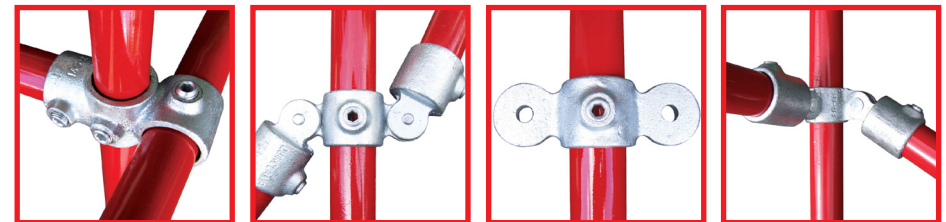

013510 Q-Clamp 165-4	013532 Q-Clamp 167-4	013530 Q-Clamp 167-4M	013533 Q-Clamp 168-4
--------------------------------	--------------------------------	---------------------------------	--------------------------------



Q-Clamps

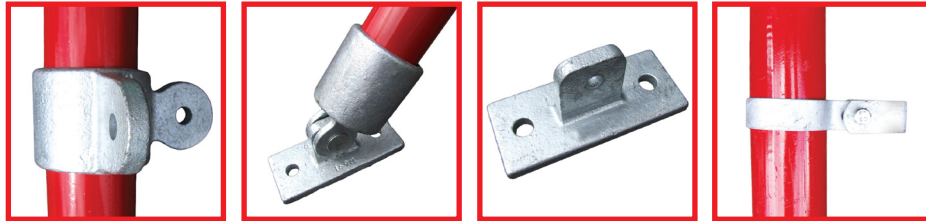

013535	013534	013562	013601
Q-Clamp 168-4M	Q-Clamp 169-4	Q-Clamp 169M	Q-Clamp 170-4

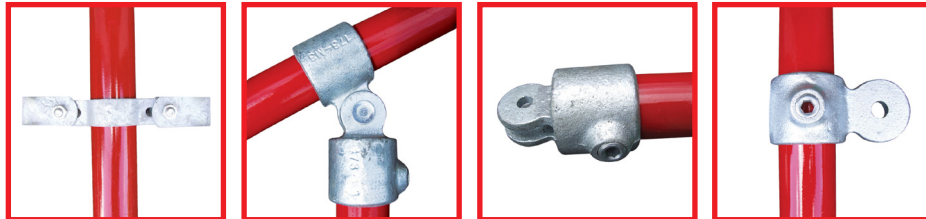

013566	013538	013434	013539
Q-Clamp 171-4	Q-Clamp 173-4	Q-Clamp 173-4F	Q-Clamp 173-4M

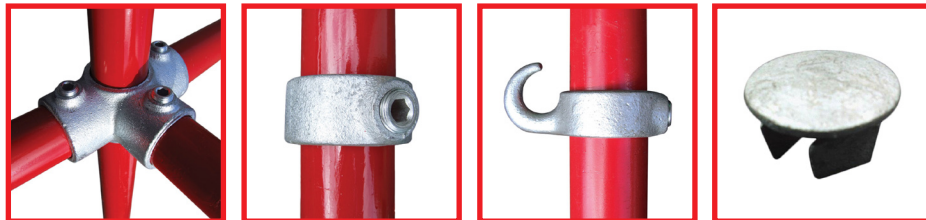

013541	013418	013545	013543
Q-Clamp 176-4	Q-Clamp 179-4	Q-Clamp 182-4	Q-Clamp 184-4

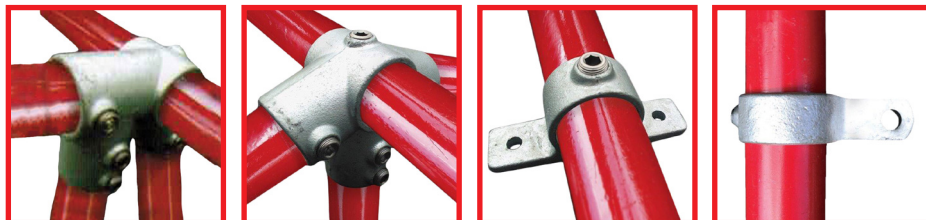

013622	013544	013446	013496
Q-Clamp 185-4	Q-Clamp 191-4	Q-Clamp 198-4	Q-Clamp 199-4



Q-Clamps

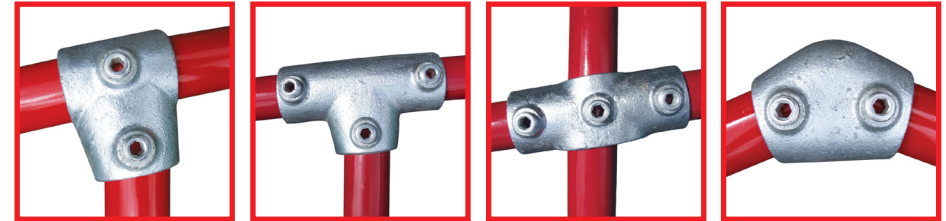

013349	013350	013351	013352
Q-Clamp 201-4	Q-Clamp 204-4	Q-Clamp 219-4	Q-Clamp 224-4

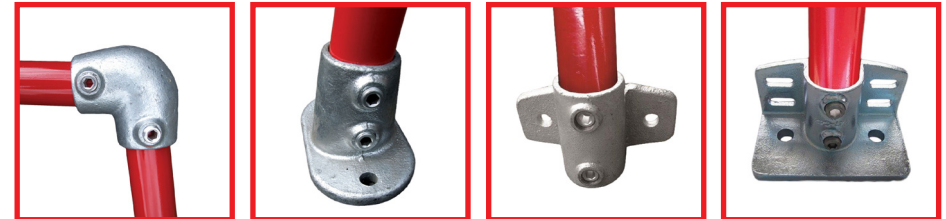

013353	013633	013653	013354
Q-Clamp 225-4	Q-Clamp 232-4	Q-Clamp 246-4	Q-Clamp 247-4



013571	013540	013575
Q-Clamp 300	Q-Clamp 301-4	Q-Clamp 302-4



**SCAN ME
TO FIND**



**YOUR LOCAL
BRANCH**



**GENERATION
HIRE & SALE**

Generation UK Ltd.
Head Office, Trinity Street, Off Tat Bank Road, Oldbury, West Midlands, B69 4LA - United Kingdom
Tel. 0121 543 2950 - Fax. 0121 543 2953 - enquiries@generationuk.co.uk
www.altradgeneration.com